



# **iOptron<sup>®</sup> CEM40 Center-Balanced Equatorial Mount**

## **Instruction Manual**

Product CEM40 (#7400A series) and CEM40EC (#7400ECA series, as shown)



Please read the included CEM40 Quick Setup Guide (QSG) BEFORE taking the mount out of the case!

This product is a precision instrument and uses a magnetic gear meshing mechanism. Please read the included QSG before assembling the mount. Please read the entire Instruction Manual before operating the mount.

You must hold the mount firmly when disengaging the gear switches. Otherwise personal injury and/or equipment damage may occur. Any worm system damage due to improper operation will not be covered by iOptron's limited warranty.

If you have any questions please contact us at [support@ioptron.com](mailto:support@ioptron.com)



## **WARNING!**

***NEVER USE A TELESCOPE TO LOOK AT THE SUN WITHOUT A PROPER FILTER!  
Looking at or near the Sun will cause instant and irreversible damage to your eye.  
Children should always have adult supervision while using a telescope.***

# Table of Contents

Table of Contents .....	3
1. CEM40 Introduction .....	5
2. CEM40 Overview .....	6
2.1. Parts List .....	6
2.2. Identification of Parts .....	7
2.3. CEM40 Mount Basic Cable Connection.....	7
2.4. CEM40 Cable Management.....	8
2.5. Go2Nova <sup>®</sup> 8407+ Hand Controller.....	10
2.5.1. Key Description .....	10
2.5.2. The LCD Screen .....	11
2.6. Bench Testing the Mount.....	12
3. CEM40 Mount Assembly .....	13
3.1. CEM40 Mount Assembly .....	13
4. Getting Started .....	23
4.1. Setting the Mount and Performing Polar Alignment.....	23
4.2. Manual Operation of the Mount .....	23
4.3. One Star Alignment .....	23
4.4. GOTO the Moon and Other Objects.....	23
4.5. Star Identification Function .....	23
4.6. Power-Down Memorization.....	24
4.7. Turning Off the Mount.....	24
4.8. Putting the Mount Back into the Carrying Case .....	24
5. Complete Functions of Go2Nova <sup>®</sup> 8407+ Hand Controller.....	25
5.1. Select and Slew .....	25
5.1.1. Solar System .....	25
5.1.2. Deep Sky Objects.....	25
5.1.3. Stars.....	25
5.1.4. Comets .....	25
5.1.5. Asteroids .....	25
5.1.6. Constellations.....	25
5.1.7. Custom Objects.....	25
5.1.8. Custom R.A. and DEC.....	26
5.2. Sync to Target.....	26
5.3. Alignment .....	26
5.3.1. Position of Polaris/SigmaOct.....	26
5.3.2. One Star Alignment .....	26
5.3.3. Two Star Alignment.....	26
5.3.4. Three Star Alignment.....	27
5.3.5. Solar System Align .....	27
5.3.6. Polar Iterate Align.....	27
5.3.7. View Model Error .....	27
5.3.8. Clear Alignment Data .....	27
5.4. Settings.....	27
5.4.1. Set Time and Site .....	27
5.4.2. Beep Settings.....	27
5.4.3. Display Settings .....	28
5.4.4. Set Guiding Rate.....	28
5.4.5. Set Tracking Rate.....	29

5.4.6. Set Parking Position.....	29
5.4.7. Meridian Treatment .....	29
5.4.8. Set Altitude Limit .....	29
5.4.9. Polar Scope Bright.....	29
5.4.10. HC Heating Switch .....	29
5.4.11. Set RA Guiding.....	30
5.4.12. Language.....	30
5.5. Electric Focuser .....	30
5.6. PEC Option .....	30
5.6.1. PEC Playback.....	30
5.6.2. Record PEC.....	30
5.6.3. PEC Data Integrity .....	30
5.7. Park Telescope .....	31
5.8. Edit User Objects .....	31
5.8.1. Enter a New Comet.....	31
5.8.2. Enter Other Objects or Observation List .....	31
5.9. Firmware Information.....	32
5.10. Zero Position.....	32
5.10.1. Goto Zero Position.....	32
5.10.2. Set Zero Position.....	32
5.10.3. Search Zero Pos. ....	32
6. Maintenance and Servicing.....	33
6.1. Maintenance.....	33
6.2. iOptron Customer Service.....	33
6.3. Product End of Life Disposal Instructions.....	33
6.4. Battery Replacement and Disposal Instructions .....	33
Appendix A. Technical Specifications .....	34
Appendix B. Go2Nova <sup>®</sup> 8407+ HC MENU STRUCTURE.....	35
Appendix C. Polar Alignment using iPolar Electronic PolarScope.....	38
Appendix D. Gear Meshing Adjustment .....	44
Appendix E. Firmware Upgrade .....	46
Appendix F. Computer Control a CEM40 Mount .....	47
Appendix G. Go2Nova <sup>®</sup> Star List.....	48
IOPTRON TWO YEAR TELESCOPE, MOUNT, AND CONTROLLER WARRANTY .....	57

# 1. CEM40 Introduction

The iOptron® CEM40 mount is the next generation of center-balanced equatorial mounts. This mount is incredibly eye-pleasing, and its beauty is found in more than its appearance. The functionality of the mount is superb. Weighing in at only 15.8lbs., this mount can support a payload of up to 40lbs! That's incredible!

This mount also has an integrated electronic polar finder scope known as the iPolar. This tool ensures the accurate alignment of a telescope, even when the pole star is obscured. There are large levers on the quick-lock drive engagement system; these large levers make it easy to snap the gears into place.

Make way for an innovative mount! This iOptron CEM40 mount uses iOptron's patent-pending Universal Self-Centering Saddle (USCS). This saddle accommodates Losmandy and Vixen-style dovetail plates. The CEM40 also uses iOptron's ultra-quiet, low-power consumption stepper motor drive system, aiding the mount in providing precise tracking.

The iOptron CEM40 mount uses the Go2Nova® 8407 hand controller to navigate the night sky. This incredible technology helps observers find celestial objects with the aid of the mount's 212,000+ object database! For those looking for a telescope that has the capability of tracking and finding beautiful night sky objects, this mount is a must have tool.

## Features:

- Unique design, Center-Balanced equatorial mount (CEM) for maximum payload and minimum mount weight
- Idea for both visual observation and astrophotography
- Maximum payload of 40 lbs (18 kg) with the mount weight of only 15.8 lbs (7.2 kg)
- All metal, CNC machined with red/black anodized
- Easy to use quick-lock gear clutches
- Integrated iPolar™ electronic polar finder
- Low periodic error:  $<\pm 7$  arc seconds for CEM40,  $< 0.25$  arcsec RMS for CEM40EC
- Permanent periodic error correction (PPEC) or Real-time periodic error correction (for CEM40EC)
- Precision stepper motor for precise GOTO and accurate tracking
- Go2Nova® 8407+ controller with Advanced GOTO NOVA® GOTO Technology with built-in heater
- Integrated ST-4 autoguiding port
- 32-channel Global Positioning System (GPS)
- USB communication port
- Cable management system
- New, patent-pending iOptron universal saddle
- Standard 1.5 inch heavy-duty stainless steel tripod (5kg), optional 2" tripod or Tri-pier
- Optional WiFi module (iStarFi, #7434) for mount control via SmartPhone/Tablet/Computer

## 2. CEM40 Overview

### 2.1. Parts List<sup>1</sup>

#### SHIPPING CONTENTS

Your new CEM40 mount comes in two shipping boxes. One box contains either a CEM40 (#7400A) or CEM40EC (#7400ECA) mount head, hand controller, counterweight shaft, and accessories. The other box contains a 1.5" tripod and a 10lbs (4.5kg) counterweight. The contents are:

- iOptron® CEM40 telescope mount (#7400A, with black gear switches) or iOptron® CEM40EC mount (#7400ECA, high precision model with red gear switches)
- Go2Nova® 8407 Hand Controller
- One 10lbs (4.5 kg) counterweight
- Stainless steel counterweight shaft
- Internal iPolar electronic polar scope
- CEM40 GPS module
- AC adapter (100V-240V)
- 2X coiled control Cable (6P6C RJ11 to RJ11, straight wired)
- Serial cable (RS232 to RJ9)
- USB cable
- Aluminum carrying case (for CEM40EC)
- 1.5" tripod
- Quick Start Guide

#### OPTIONAL PARTS

- 2" tripod
- Tri-Pier (#8034)
- iStarFi wireless adapter (#7434)
- USB to RS232 Converter with FTDI chipset (#8435)

#### ONLINE RESOURCES *(click on the "Support" menu at [www.iOptron.com](http://www.iOptron.com))*

- Quick Start Guide
- Instructional manual
- Tips for set up
- Hand controller and mount firmware upgrades (check online for latest version)
- iOptron ASCOM driver
- Reviews and feedback from other customers
- Accessories

---

<sup>1</sup> US market only. Actual contents, design and function may vary.

## 2.2. Identification of Parts



Figure 1.CEM40 mount assembly

## 2.3. CEM40 Mount Basic Cable Connection



Figure 2. Ports on a CEM40 mount

- OFF/ON (O/I): Power Switch
- DC 12V: DC power socket to power the mount (2.1mmX5.5mm, center positive)
- HBX (Hand Box): For connecting to an 8407 Hand Controller
- iPORT: Auxiliary port for connecting to other iOptron accessories, such as a GPS receiver, an iStarFi WiFi adapter, an electronic focuser or for observatory dome control. **DO NOT** plug ST-4 guiding camera cable into this port, It will damage the guide camera electronics.

- USB: USB port for mount-computer control and firmware upgrade

## 2.4. CEM40 Cable Management

The CEM40 mount has a pre-wired Cable Management Panel (CMP). As shown in Figure 3, the Cable Management Panel has the following connections:



Figure 3. Cable management panel

- 1X USB 2.0 ports with standard type A connectors for connecting accessory;
- 1X DC12V power outlet (2.1mmX5.5mm, center positive, max. current 3A) for powering accessories such as CCD cameras, filter wheels, or electric focusers;
- GUIDE: ST-4 compatible autoguiding port. The wiring is shown in Figure 4

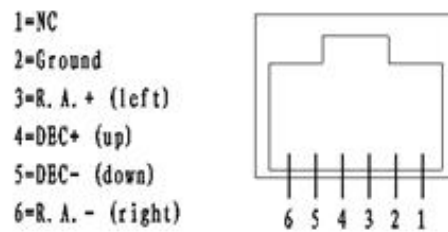

Figure 4. ST-4 Compatible Guiding Port Wiring

The USB-A port on the Cable Management Panel are connected to the USB-B connector on Input Panel, as shown in Figure 5.



Figure 5. Input panel

- 1x USB 2.0 port with a standard type B connector
- 1X iPolar USB port for internal iPolar electronic polar scope connection

There is a hole on dovetail saddle that allows a user to run his own cables down through the mount, to either the back of RA axle or bottom of the DEC axle.





Figure 6. Openings for custom cable management

The CMP can also be moved from the back of the dovetail saddle to the front.

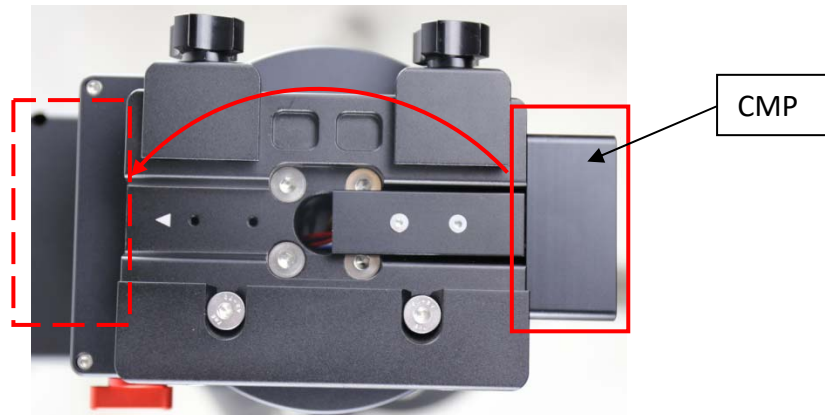

Figure 7. Top of the dovetail saddle

## 2.5. Go2Nova<sup>®</sup> 8407+ Hand Controller

The Go2Nova<sup>®</sup> 8407+ hand controller (HC) shown in Figure 8 is the standard controller used on the CEM40 mount. It has an integrated heater that ensures the LCD display will work at the temperature as low as -20°C(-4°F). It has a large LCD screen, function, direction, and number keys on the front; a red LED reading light on the back; and a HBX (6-pin) and a RS232 serial port (4-pin) at the bottom.

**The CEM40 mount can be operated without the hand controller attached if it is controlled via a SmartPhone/Tablet/Computer.**



Figure 8. Go2Nova<sup>®</sup> 8407+ hand controller

### 2.5.1. Key Description

- MENU Key: Press “MENU” to enter the Main Menu.
- BACK Key: Move back to the previous screen, or end/cancel current operation, such as slewing.
- ENTER Key: Confirm an input, go to the next menu, select a choice, or slew the telescope to a selected object.
- Arrow (▲▼◀▶) Keys: The arrow keys are used to control the movement of DEC and R.A. axes. Press and hold ▲(DEC+),▼(DEC-) buttons to move a telescope along the DEC direction, ◀(R.A.+), ▶(R.A.-) to move a telescope along the R.A. direction. They are also used to browse the menu or move the cursor while in the menu. Press and holding an arrow key for a fast scrolling.
- Number Keys: Input numerical values. Also used to adjust speeds (1: 1X; 2: 2X; 3: 8X; 4: 16X; 5: 64X; 6: 128X; 7: 256X; 8: 512X; 9: MAX)
- Light Key(☀): Turns on/off the red LED reading light on the back of the controller.
- Help (?) Key: Identify and display bright stars or objects that the telescope is pointing to.

- STOP/0 Key: Stop the mount during GOTO. Also toggling between starting and stopping tracking.
- HBX (Handbox) port: connect the HC to the CEM40 mount using a 6P6C RJ11 cable.
- Serial port: connect the HC to a computer via a RS232 to 4P4C RJ9 cable. The pin-out of the serial port is shown in Figure 9.

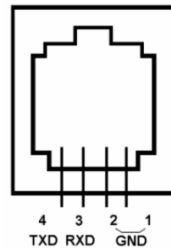

Figure 9. Serial port pin-out on an 8407+ hand controller

### 2.5.2. The LCD Screen

The 8407+ HC has a large 8-line, 21-character per line, LCD screen which displays information on the status of the mount as shown in Figure 10. The user interface is simple and easy to operate.

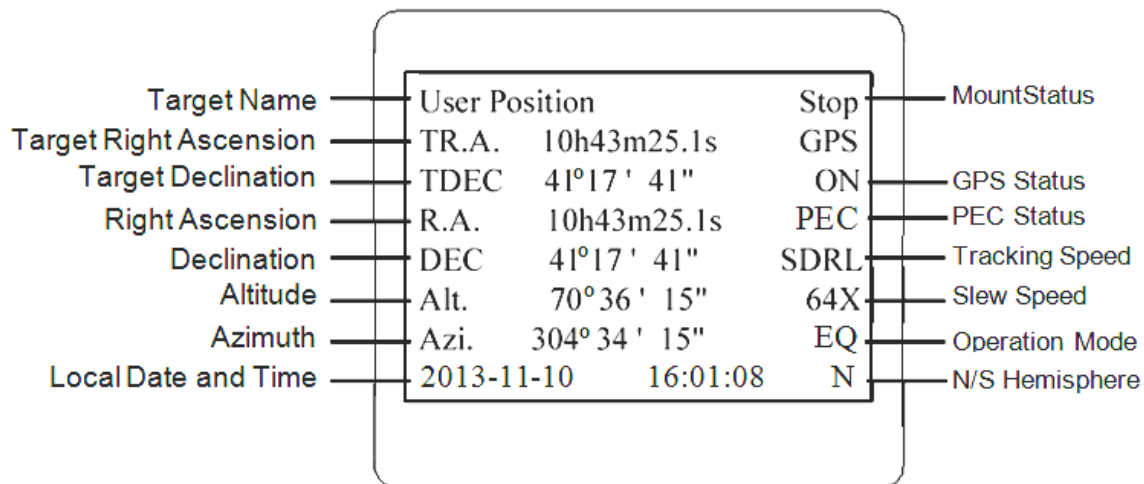

Figure 10. 8407+ HC LCD Information Screen

1. Target Name/Mount Position: displays the name of the target that telescope is currently pointed to or the current mount position.
  - Zero Position: The reference position for GOTO. The mount can move to Zero Position using “**Goto Zero Position**” or “**Search Zero Position**” command;
  - User Position: The mount is pointed to a user defined position, which could be a particular celestial object or simply a position determined by pressing an arrow key;
  - An object name, such as “Mercury” or “Andromeda Galaxy”: Name of the star or celestial object that the mount is currently slewing to or tracking.
2. Target R.A.: Right Ascension (R.A.) of the target object.
3. Target Declination: Declination (DEC) of the target object.
4. Right Ascension: Current R.A. of the telescope.
5. Declination: Current DEC of the telescope.
6. Altitude: Altitude of the telescope (degrees vertical from the local horizon - zenith is 90°).
7. Azimuth: Azimuth of the telescope (north is 0°, east is 90°, south is 180°, and west is 270°).

8. Local Date and Time: displays the local time in a format of YY-MM-DD HH:MM:SS.
9. Mount Status: Displays the current operational status of the mount.
  - Stop: mount is not moving;
  - Slew: mount is moving with an arrow key is pressed or a GOTO command, such as “**Select and Slew**” or “**Goto Zero Position**”;
  - Tracking: mount is at a tracking status.
10. GPS status: When the power is turned on, the initial GPS status will be “GPS ON”, which means that the mount is connected to its GPS receiver and is seeking a satellite signal. When the GPS receiver finds the satellites and receives the GPS signal the status will change to “GPS OK”.
11. PEC status: Display of “PEC” here Indicates the Periodic Error Correction playback is turned on. Default is off.
12. Tracking speed: Displays the current tracking rate of the mount.
  - SDRL: mount is tracking at sidereal speed;
  - Solar: mount is tracking at solar speed;
  - Lunar: mount is tracking at lunar speed;
  - King: mount is tracking at king speed;
  - CSTM: mount is tracking at a custom, user-defined speed.
13. Slew speed: The mount has 9 slew speeds: 1X, 2X, 8X, 16X, 64X, 128X, 256X, 512X, MAX (~4°/sec).
14. Operation Mode: EQ indicates that the mount is operating in an equatorial mode.

## 2.6. Bench Testing the Mount

The counterweight shaft is designed to counter balance the mount’s own weight. It is recommended that the CW shaft is installed when testing the mount’s function, as shown in Figure 11.



Figure 11. Setup for initial mount testing

Slewing the mount without the CW shaft installed ***is not recommended***.

***NEVER operate the mount with only the counterweight or OTA on it. It may damage the precision engineering of the mount drive system.***

## 3. CEM40 Mount Assembly

### 3.1. CEM40 Mount Assembly

**NOTE:** The CEM40 mount is a precision astronomical instrument. It is highly recommended that you read this entire manual and become familiar with the nomenclature and function of all components before starting assembly.



**WARNING: DO NOT** rock the counterweight shaft rigorously. This may damage the worm/drive gear system and such damage will not be covered by warranty.

#### STEP 1. Remove the mount head from package

The mount head is shipped with the R.A. Gear Switch unlocked to protect the worm/gear system. Turn the Gear Switch 90° to lock the R.A. gear system before removing it from the box.



Figure 12. Mount in a hard case

#### STEP 2. Set up tripod

The tripod top is 120 mm in diameter with 2x M6 holes 103 mm apart for mounting. Two additional M6 holes are for the Alignment Peg (the one on top of a leg is for high latitude use; the other one between two legs is for low latitudes). Thread the Alignment Peg into the correct M6 hole. Insert the Accessory Tray through the center rod and secure the setup by tightening Locking Knob from underneath.



Figure 13. Tripod top

### STEP 3. Attach the mount

Retract the 2x Azimuth (Azi) Adjustment Screws from both sides to leave ample space for the alignment peg to fit in between the 2 Azi Adjustment Screws. Remove the 2x Azi Locking Screws, with washers, from the mount base. Secure the mount head by tightening the Azi Locking Screws into the M6 holes on the tripod. An Allen wrench is included for convenience.



Figure 14. Attach the mount

Level the mount by adjusting the tripod legs. Use the build-in Bubble Level Indicator or an external leveler for this purpose.

### STEP 4. Adjust latitude

Without any payload, slightly loosen the 4x Latitude Locking Screws. Use the Latitude Adjustment Knob to set the correct latitude value, as displayed in the Latitude Mark Window. Insert the Allen wrench into the Latitude Adjustment Knob for more turning torque.



Figure 15. Adjust latitude

Two latitude ranges, 0~35° and 25~60°, can be set up for the mount head. To change the latitude range from one to the other, **both** the Latitude Position Bolt and the Latitude Locking Screws need to be moved to the correct locations (see photos below).

Loosen the Latitude Locking Screws just enough to adjust the latitude setting to 30°. Move the Latitude Locking Screws with washers (one on each side) to the new locations revealed, do not tighten them just yet.



Figure 16. Latitude mark window

Unthread and remove the Position Bolt to its new location. Adjust the Latitude Adjustment Knob while holding the brass eyebolt until it lines up with the Position Bolt. Secure the Latitude Position Bolt.

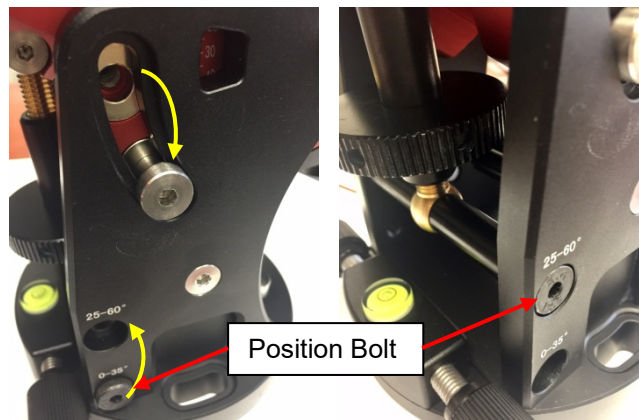

Figure 17. Change latitude range

### STEP 5. Install Counterweight (CW) Shaft

Thread the CW shaft into the CW shaft mounting house. For low latitudes ( $<10^\circ$ ), a special CW mounting house is needed. (Contact iOptron for more information)



Figure 18. Install CW shaft

### STEP 6. Install Counterweight(s)

Before putting on CW, make sure the mount is at its zero position, i.e., CW shaft points to the ground. **Disengage the R.A. Gear Switch to set the R.A. axis free before loading the CW.** Remove the CW Safety Cap at the end of CW Shaft. Glide the CW over the shaft with the larger hole opening facing down. Tighten the CW Locking Screw to hold the CW in place. Place the Safety Cap back onto the shaft. Move the CW to the bottom of the shaft and tighten the CW locking Screw. Move the CW to the bottom of the shaft and tighten the CW locking Screw.



Figure 19. Install Counterweight

**You may need more CW for heavier payloads, or a smaller CW for lighter scopes.**

### STEP 7. Install Telescope

CEM40 is equipped with a 5" iOptron Universal Saddle. It can receive either a Vixen or a Losmandy-D plate by flipping both Stationary Block and Locking Block. This unique adjustable dovetail saddle enables the scope to sit at the center of the saddle.

The following graphics show how to change the dovetail saddle to fit either Vixen or Losmandy plate.

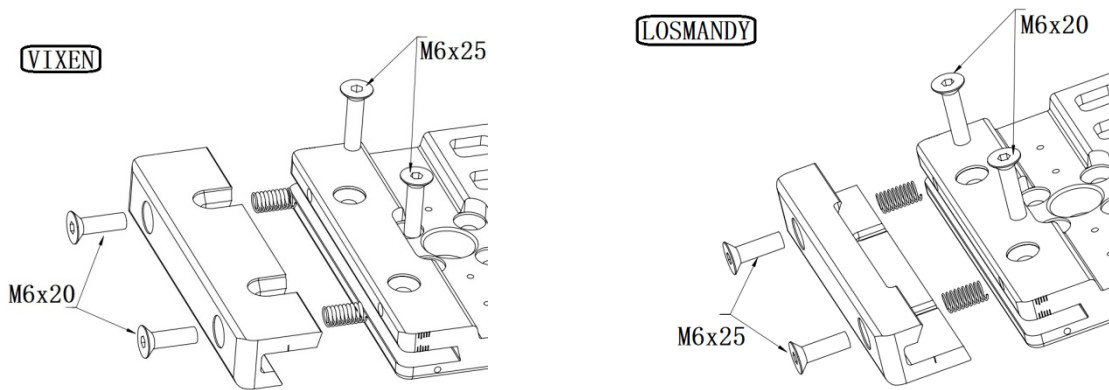

Figure 20. Switch the dovetail saddle from Vixen to Losmandy (Stationary Side)

**Please Note that two sets of screws have different lengths and must swap location.**

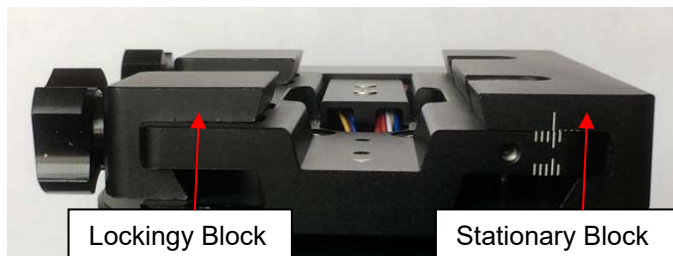

Figure 21. Vixen dovetail saddle



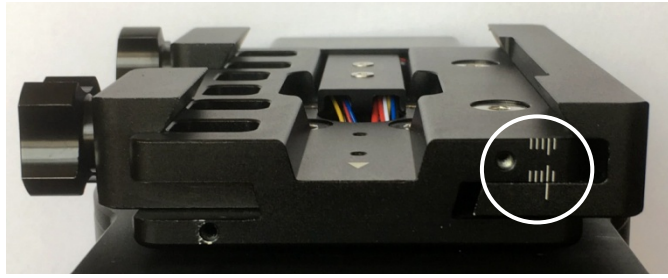

Figure 22. Losmandy dovetail saddle

After switch the Stationary and Locking Blocks, make sure that the alignment mark on the Stationary Block is aligned to one of the position marks on the saddle plate. If you have a wider dovetail plate, move the Stationary Block to an outside mark. For a narrow plate, move the Stationary Block to an inside mark. The marks are located on both end of the saddle plate.

### STEP 8. Balance the Payload

After attaching the scope and accessories, the mount head assembly must be balanced in both DEC and RA axes to ensure minimum stresses on the mount driving mechanism.



**CAUTION:** The telescope may swing freely when the R.A. or DEC Gear Switch is disengaged. Always hold on to the mount and/or telescope assembly before releasing the Gear Switches to prevent it from swinging, which can cause personal injuries and/or equipment damages.

Set the mount at Zero Position. Disengage both RA and DEC gear switches and move the mount to horizontal position to check balance. Return to Zero Position for balance adjustment. Balance the DEC axis by moving the scope with accessories back and forth in the mount saddle or within the scope mounting rings. Balance the assembly in R.A. axis by moving CW along its shaft. Repeat the process until both DEC and RA axes are balanced.

**CAUTION:** The balancing process **MUST** be done with Gear Switch at the total disengaged position! Otherwise it might damage the worm system.

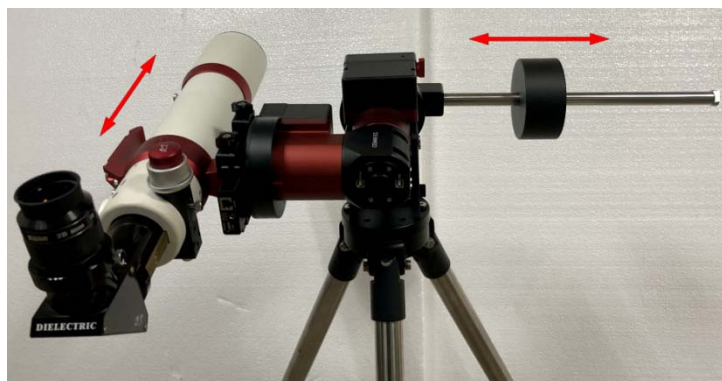

Figure 23. Balance a mount

Return the mount to Zero Position after balancing and engage gear switches.

### STEP 9. Connect Cables

Plug in a 12V DC power supply to the DC12V POWER socket. Connect the Go2Nova® 8407 Hand Controller to the HBX port on the mount side panel.



Figure 24. Ports for cables

Plug GPS module into the iPORT with coiled cable. When powering on, GPS ON sign should be displayed at the upper right corner of the hand controller. If you want to use the iPort for another accessory, such as WIFI adapter (iStarFi #7434), or electronic focuser (#8451/#8452), you may disconnect the GPS module after it picks up satellites signals and displays GPS OK on hand controller. (It takes about 1 to 2 minutes in normal conditions).

### STEP 10. Setting up the Hand Controller

The CEM40 mount is equipped with a GPS receiver which will receive the time, longitude and latitude information for your current location from satellites after a link is established. However, there are still some parameters which need to be entered to reflect your location, such as time zone information and whether daylight saving time is currently in effect. This information will be stored in the hand controller memory along with longitude and latitude coordinates until they need to be updated.

A clear sky and open space outside is needed for the GPS to establish a link with the satellites.

To set up the controller, press **MENU** =>“Settings”:

```

Select and Slew
Sync. to Target
Alignment
Settings
Electric Focuser
PEC Options
Park Telescope
Edit User Objects
  
```

Press **ENTER** and select “Set Time and Site”

```

Set Time and Site
Beep Settings
Display Settings
Set Guiding Rate
Set Tracking Rate
Set Parking Position
Meridian Treatment
Set Altitude Limit
  
```

Press **ENTER**. A time and site information screen will be displayed:

```

Daylight Saving Time  Y
UTC -300 Minute(s)
2019-03-09 10:19:18

Longitude:W071d08m50s
Latitude:  N42d30m32s

Northern Hemisphere

```

### **Set Local Time**

The time will be updated automatically when the GPS receiver has established its link to the satellites. In the event that the GPS module is unable to establish a link, local time can be entered manually. Use the ◀ or ▶ key to move the cursor █ and use the number keys to change the numbers. Use the ▲ or ▼ button to toggle between “Y” and “N” for Daylight Saving Time, or “+” and “-” for UTC (Coordinated Universal Time) setting. Hold the arrow key to fast forward or rewind the cursor.

In order to make the Hand Controller reflect your correct local time, **time zone information has to be entered**. Press the ◀ or ▶ key, move the cursor to the third line “UTC -300 Minute(s)” to set the time zone information (add or subtract 60 minutes per time zone). For example:

- Boston is “UTC -300 minutes”
- Los Angeles is “UTC -480 minutes”
- Rome is “UTC +60 minutes”
- Beijing is “UTC +480 minutes”
- Sydney is “UTC +600 minutes”

All the time zones in North America are “UTC -”, as shown in the following table, so ensure the display shows “UTC -” instead of “UTC +”.

Time Zone	Hawaii	Alaska	Pacific	Mountain	Central	Eastern
Hour behind UT	-10	-9	-8	-7	-6	-5
Enter UTC	-600	-540	-480	-420	-360	-300

To adjust minutes, move the cursor to each digit and use the number keys to input the number directly. Use ▲ or ▼ key to toggle between “+” and “-”. When the time one information entered is correct, press ENTER and go back to the previous screen. **Note that fractional time zones can be entered.**

Do not manually add or subtract an hour from displayed time to reflect Daylight Saving Time (DST). Only select “Y” after DST begins.

For other parts of the world you can find your “time zone” information from internet.

### **Set Observation Site Coordinates**

The fifth and sixth lines display the longitude and latitude coordinates, respectively. The longitude and latitude coordinates will be automatically updated when the GPS picks up a satellite signal. “W/E” means Western/Eastern Hemisphere; “N/S” means Northern/Southern Hemisphere; “d” means degree; “m” means minute; and “s” means second.

If, for any reason, your GPS does not pick up the satellite signal, you can manually enter your longitude and latitude coordinates. Press the ◀ or ▶ key to move the cursor, use the ▲ or ▼ key to toggle between “W” and “E”, and “N” and “S”, and use the number keys to change the numbers. It is always a good idea to do your homework and get longitude and latitude coordinates before traveling to a new observation site.

The site coordinates information can be found from your smart phone, GPS receiver or via the internet. Site information in decimal format can be converted into d:m:s format by multiplying the decimal

numbers by 60. For example, N47.53 can be changed to N47°31'48":  $47.53^\circ = 47^\circ + 0.53^\circ$ ,  $0.53^\circ = 0.53 \times 60' = 31.8'$ ,  $0.8' = 0.8 \times 60'' = 48''$ . Therefore,  $47.53^\circ = 47^\circ 31' 48''$  or 47d31m48s.

### **Select N/S Hemisphere**

The northern/southern hemisphere will be determined by your latitude coordinate, with one exception. If you are near the equator (within +/- 10°), you can choose your own N/S setting.

If the polar axis is aligned to the North Celestial Pole, then set the mount to Northern Hemisphere. If the polar axis is pointing to the South Celestial Pole, set the mount to Southern Hemisphere. Press the ◀ or ▶ key to move the cursor and use the ▲ or ▼ key to toggle between "Northern Hemisphere" and "Southern Hemisphere".

The time and site information will be stored inside the hand controller's memory chip. If you are not traveling to another observation site, they do not need to be changed.

### **Check the Hand Controller Battery**

The hand controller has a real time clock (RTC) which should display the correct time every time the mount is turned on. If the time is incorrect, please check the battery inside the hand controller and replace it if required. The battery is a 3V, CR1220 button battery.

## **STEP 11. Set the Zero Position**

Zero Position is the mount starting reference point which ensures the GOTO performance. Press **MENU** => "**Zero Position**" => "**Search Zero Position**" to let the mount search the Zero Position. Follow the instruction on hand controller display to adjust the Zero Position if RA or DEC is not aligned. Or press **MENU** => "**Zero Position**" => "**Set Zero Position**", to manually set the mount to Zero Position. Loosen the DEC and R.A. Gear Switches in turn to adjust the mount to the Zero Position. Engage the clutches after each adjustment.

## **STEP 12. Perform Polar Alignment**

### **Polar Alignment with iPolar Electronic Polar Scope**

CEM40 & CEM40EC are equipped with an iPolar™ electronic polar scope. To perform polar alignment, please refer to **Appendix C**. It is simple and fast, even the pole star or part of the sky is blocked. Steps are briefly outlined below:

- Download and install iPolar Software (first time use)
- Connect a USB cable between the iPolar port on the mount and a computer USB port
- Calibrate the iPolar Rotation Center (first time use)
- Click Connect and start polar alignment by following on screen instructions

### **Quick Polar Alignment**

If the mount equipped with a AccuAlign™ optical polar scope, you can use the Quick Polar Alignment procedure to perform the polar alignment. One of the CEM40's unique features is that the polar scope can be used at anytime as it is not blocked by DEC axle as is the case in a German Equatorial Mount. This makes it possible to adjust the polar alignment while the mount is tracking.

As indicated in Figure 25, the Polar Scope reticle™ has been divided into 12 hours along the angular direction with 20-minute tics. There are 6 concentric circles in 2 groups of 3 marked from 36' to 44' and 60' to 70', respectively. The 36' to 44' concentric circles are used for polar alignment in the Northern Hemisphere using Polaris, while the 60' to 70' circles are used for polar alignment in Southern Hemisphere using Sigma Octantis.

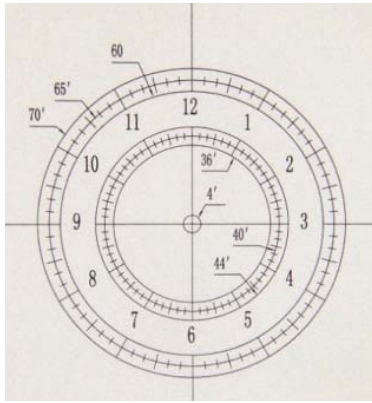

Figure 25. Polar Scope



Figure 26. Connect polar scope LED

To perform the polar alignment:

- (1) Level the CEM40 mount and set it to the Zero Position. Make sure the telescope optical axis is parallel to the polar axis (R.A. axis) of the mount. If using a finder scope, adjust it to be parallel to the telescope optical axis.
- (2) Remove both the Polar Axis Cover and Polar Scope Cover. Thread the polar scope LED to the Polar Scope. Connect one end of the polar scope power cable to the illumination LED and the other end to the DC12V output located on DEC Cable Management Panel (Figure 26).
- (3) Turn the mount power on. Use the Hand Controller ("**Settings**" => "**Polar Scope Brightness**") to set the illumination intensity.
- (4) Adjust the polar scope dial to rotate the 12 o'clock at the top.
- (5) Use the Hand Controller (**MENU** => "**Alignment**" => "**Position of Polaris/SigmaOct**") to display the current position of Polaris on the LCD screen, as indicated in the left side of the figure below. For example, June 22, 2014, 20:19:42 in Boston, US (long. W71°08'50" and lat. N42°30'32", UTC - 300 min,) the Polaris Position is 0h45.8m and 40.4m.

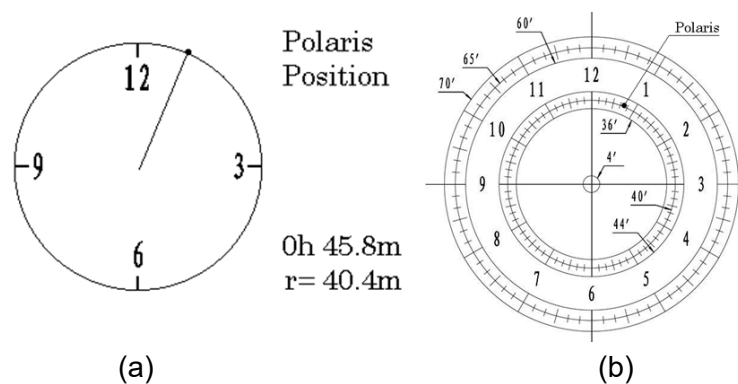

Figure 27. Polaris Position shown on HC (a) and where to put on polar scope reticle (b)

- (6) Look through the polar scope to find the Polaris. Use the Azimuth and Latitude Adjustment Knobs to adjust the mount in both directions and put the Polaris in the same position on the Polar Scope reticle as indicated on the HC display screen. In this case, Polaris will be located at a radius of 41.5 minutes and an angle of 1 hour 26.8 minutes, as shown in Figure 27 (b).

**NOTE: If you are located in the Southern Hemisphere, Sigma Octantis will be chosen for Polar Alignment.**

### **BrightStar Polar Alignment**

If your mount does not have a iPolar installed, or the pole star is not in sight, you may use two bright stars with **Polar Iterate Align** to do the polar alignment.

- (1) Level the mount and set it to the Zero Position. Align the telescope to the R.A. axis of the mount. If a finder scope is used, adjust it to be parallel to the telescope optical axis.
- (2) Use the HC (**MENU** => "**Alignment**" => "**Polar Iterate Align**") to display the azimuth and altitude position of several bright stars near the meridian. Select one that is visible at a high altitude as Alignment Star A. Follow the HC instruction to move Alignment Star A to the center of the eyepiece using a combination of the Latitude Adjustment Knob and the "◀" or "▶" buttons. Press **ENTER** to confirm when the star is centered. Next, select a bright star that is close to the horizon as Alignment Star B. Center it using the Azimuth Adjustment Knob and the "◀" or "▶" button (*the "▲" and "▼" buttons are not used here*). Press **ENTER** to confirm the settings.
- (3) The telescope will now slew back to Alignment Star A. Repeat the steps above. The iteration can be stopped when it is determined that the alignment error has been minimized. Press the **BACK** button to exit the alignment procedure.

**NOTE:** It is highly recommended to use an eyepiece with an illuminated crosshair for accurate centering.

**NOTE:** The movement of the alignment star in your eyepiece may not be perpendicular depending on its location in the sky.

### **STEP 13. Returning the Mount to Zero Position**

After polar alignment and balancing OTA, return the mount to the Zero Position. Please check the zero position after set up the mount or firmware update.

## 4. Getting Started

In order to experience the full GOTO capability of GOTONOVA<sup>®</sup> technology it is very important to set up the mount correctly before observation.

### 4.1. Setting the Mount and Performing Polar Alignment

Assemble your CEM40 mount according to Section 3.1. Make sure the mount is leveled. Turn the mount power switch on. When the GPS receiver is connected to satellites, the hand controller LCD will display GPS OK and the mount will have the correct time and site information (this can also be entered manually as previously described). Mount an OTA and accessories, and carefully balance the mount on both R.A. and DEC axes. Perform the polar alignment.

After the mount is powered on, perform **MENU** => “**Zero Position**” => “**Goto Zero Position**” to check the Zero Position, i.e. with the counterweight shaft pointing to ground, OTA at the highest position with its axis parallel to the polar axis and the telescope pointing to the Celestial Pole. If the mount is not at the Zero Position, you may perform **Search Zero Position** or **Set Zero Position** to set the Zero Position.

### 4.2. Manual Operation of the Mount

The mount can now be used to observe astronomical objects using the HC. Use the arrow keys (▶, ◀, ▼, and ▲) to point the telescope to the desired part of the sky. Use the number keys to change the slewing speed. Press the **STOP/0** button to start tracking.

### 4.3. One Star Alignment

After the mount set up, perform a “**One Star Align**” to correct the Zero Position discrepancy, or linear error.

Press **MENU** => “**Alignment**” => “**One Star Align**” to perform “**One Star Align.**” The hand controller will display an alignment star. Select a different star using the ▲ or ▼ keys. Then press **ENTER**. After the mount slews to the target, use the arrow keys to center it in your eyepiece. Then press **ENTER**. (More details on the alignment function are given in section 5.3)

### 4.4. GOTO the Moon and Other Objects

Now the mount is ready for GOTO operation which, using advanced GOTONOVA<sup>®</sup> technology, will automatically slew to, and track, a huge range of celestial targets. We will use the Moon as an example.

Press **MENU** => “**Select and Slew**”. Select a category, in this example “**Solar System**”, and then select an object of interest, in this case “**Moon**”. Press **ENTER** and the telescope will slew to the moon and automatically start tracking. If the target is not centered in your eyepiece, use the arrow keys to center it. Then use **MENU** => “**Sync to Target**” for better performance.

### 4.5. Star Identification Function

The 8407+ hand controller has a star identification function. After setting the correct local time and location and completing polar alignment, slew the telescope to a bright star manually or using the GOTO function. Press the Help(?) key to identify the star that the telescope is pointing to, as well as nearby bright stars if there is any.

#### ***4.6. Power-Down Memorization***

The CEM40 mount can memorize its R.A. and DEC positions if the mount power is lost during operation, even during high speed slewing. After the power is back, just do a **Select and Slew** to the same star when the power is lost. The mount will continue to track the star.

#### ***4.7. Turning Off the Mount***

When you have finished your observation, simply turn the mount power off and disassemble the mount and tripod.

If the mount is set up on a pier or inside an observatory, it is recommended that you return the mount to the Zero Position or park the telescope. This will ensure that there is no need for you to perform the initial setup again when you power on the mount subsequently so long as the mount has not been moved from the parked position.

#### ***4.8. Putting the Mount Back into the Carrying Case***

It is recommended to disengage the gear system for transportation.



## 5. Complete Functions of Go2Nova® 8407+ Hand Controller

### 5.1. Select and Slew

Press the **MENU** button. From the main menu select “**Select and Slew**”. Select an object that you would like to observe and press the **ENTER** key.

The Go2Nova® 8407+ hand controller has a database of around 212,000 objects. Use the ► or ◀ buttons to move the cursor. Use the number buttons to enter a number, or the ▼ or ▲ buttons to change a number. Hold a button to fast scroll through the list. The “◊” symbol indicates that the object is above the horizon, and the “◌” symbol means it is below the horizon. In some catalogs the stars below the horizon will not be displayed on the hand controller.

#### 5.1.1. Solar System

There are 9 objects in the Solar System catalog.

#### 5.1.2. Deep Sky Objects

This menu includes objects outside our Solar System such as galaxies, star clusters, quasars, and nebulae.

- Named Objects: consists of 92 popular deep sky objects with their common names. A list of named deep sky objects is included in Appendix E.
- Messier Catalog: consists of all 110 Messier objects.
- NGC Catalog: consists of 7,840 objects.
- IC Catalog: consists of 5,386 objects.
- PGC Catalog: consists of 73,197 objects.
- Caldwell Catalog: consists of 109 objects.
- Abell Catalog: consists of 4,076 objects.
- Herschel Catalog: consists of 400 objects.

#### 5.1.3. Stars

- Named Stars: consists of 259 stars with their common names. They are listed alphabetically; a list is included in Appendix E.
- Double/Multi Stars: consists of 208 double/multi stars; a list is attached in Appendix E.
- Hipparcos Catalog: the new HIP catalog consists of 120,404 records (2008).

#### 5.1.4. Comets

This catalog contains 15 comets.

#### 5.1.5. Asteroids

This catalog contains 116 asteroids.

#### 5.1.6. Constellations

This catalog consists of 88 modern constellations. They are listed alphabetically; a list is attached in Appendix E.

#### 5.1.7. Custom Objects

This allows the storage of up to 60 user-defined objects, including comets.

### 5.1.8. Custom R.A. and DEC

Here you can go to a target by entering its R.A. and DEC coordinates.

## 5.2. Sync to Target

This operation will match the telescope's current coordinates to the Target Right Ascension and Declination. It can be used to correct GOTO pointing error. After slewing to an object, press **MENU** - then scroll to "**Sync to Target**" and press **ENTER**. Follow the screen to perform the sync. Using this function will re-align the telescope to the selected object. Multiple syncs can be performed if needed. This operation is useful to find a faint star or nebula near a bright star.

"**Sync to Target**" will only work after "**Select and Slew**" is performed. You can change the slew rate to make the centering procedure easier. Simply press a number (1 through 9) key to change the speed. The default slew rate is 64x.

## 5.3. Alignment

This function is used for aligning the telescope to the celestial pole and to create a sky model to calibrate the mount's GOTONOVA<sup>®</sup> functionality.

The system provides four alignment methods to calibrate the mount's GOTO function: "**Solar System Align**", "**One Star Alignment**", "**Two Star Alignment**" and "**Three Star Alignment**". The "**Two Star Alignment**" may be used to refine the polar alignment.

The mount has to be set to Zero Position before performing any alignment.

### 5.3.1. Position of Polaris/SigmaOct

This function displays the position of the Pole Star for **Quick Polar Alignment** using the iOptron<sup>®</sup> AccuAlign<sup>™</sup> polar scope. In the Northern Hemisphere the position of Polaris is displayed, while in the Southern Hemisphere the position of Sigma Octantis is shown.

### 5.3.2. One Star Alignment

Press **MENU** => "**Alignment**" => "**One Star Align**". A list of alignment stars that are above the horizon is computed based on your local time and location. With the mount in the Zero Position, use the ▲ and ▼ buttons to select a star and press **ENTER**. Center the target in your eyepiece using the arrow keys. Press **ENTER** when finished. If your mount is set up correctly and polar aligned, one star alignment should be sufficient for good GoTo accuracy. To increase the pointing accuracy over the sky, you may choose to do a three star alignment.

### 5.3.3. Two Star Alignment

**Two Star Alignment** can be used to improve the accuracy of the mount's polar alignment. Press **MENU** => "**Alignment**" => "**Two Star Alignment**". A list of alignment stars that are above the horizon is computed based on your local time and location. With the mount at the Zero Position, use the ▲ and ▼ buttons to select the first alignment star and press **ENTER**. Center the target in your eyepiece using the arrow keys after the mount slews to it. Press **ENTER** when finished. The hand controller will prompt you to choose a second star. After centering the second star, the two-star alignment is finished.

After **Two Star Alignment**, the altitude and azimuth errors will be displayed. This number can be used to fine tune the Quick Polar Alignment.

For example, if the screen shows 7.5" low and 4.3" east, it means that THE MOUNT axis is pointing lower than and to the east of the Celestial Pole.

### 5.3.4. Three Star Alignment

The three-star alignment will further determine the cone error between the OTA and mount axis. The system will use these data to calculate the goto model. If the cone error is big enough, it is suggested to shim the OTA in DEC to minimize it.

Press **MENU** => “**Alignment**” => “**Three Star Alignment**,” a list of alignment stars that are above the horizon is computed based on your local time and location. With the mount at the Zero Position, use the ▲ and ▼ buttons to select the first alignment star and press **ENTER**. Center the target in your eyepiece using the arrow keys. Press **ENTER** when finished. The hand controller will prompt you to choose a second star. Select third star after the mount aligned to the second star.

The system will display the pointing and cone errors after the three star alignment is accepted. The system will update the pointing model accordingly.

### 5.3.5. Solar System Align

This function uses a planet or the moon as an alignment object. Press **MENU** => “**Alignment**” => “**Solar System Align**” for a list of available alignment objects.

### 5.3.6. Polar Iterate Align

This alignment method allows you to polar align the mount even if you cannot view the Celestial Pole. Press the **MENU** button, then select “**Alignment**” and “**Polar Iterate Align**”. The HC will display a list of bright alignment stars near the meridian as Alignment Star A. Follow the HC instructions to move Alignment Star A to the center of the eyepiece using a combination of the Latitude Adjustment Knob and the “◀” and “▶” buttons. Press **ENTER** to confirm the settings. Next, select a bright star that is close to the horizon as Alignment Star B. Center it using the Azimuth Adjustment Knobs and the “◀” and “▶” buttons (*the “▲” and “▼” buttons will not function*). Press **ENTER** to confirm the settings.

The telescope will now slew back to Alignment Star A to repeat the above steps. The iteration can be stopped when it is determined that the alignment error has been minimized. Press the **BACK** button to exit the alignment procedure.

**NOTE:** It is highly recommended to use an eyepiece with illuminated crosshairs for accurate centering.

**NOTE:** The movement of the alignment star in your eyepiece may not be perpendicular depending on its location in the sky.

### 5.3.7. View Model Error

This will display linear RA error, linear DEC error, polar misalignment, non-perpendicular between OTA and DEC, and non-perpendicular between HA and DEC.

### 5.3.8. Clear Alignment Data

This will clear all alignment data created during star alignment process. If you are controlling the mount using planetarium software via ASCOM, and the software has its own alignment function, *please clear the alignment data*.

## 5.4. Settings

### 5.4.1. Set Time and Site

Refer to STEP 9 in Section 3.1.

### 5.4.2. Beep Settings

The Hand Controller allows a user to turn off the beep partially, or even go to a silent mode. To change this setting press “**MENU** => **Settings** => **Beep Settings**”,

```
Set Up Time and Site
Beep Settings
Display Settings
Set Guiding Rates
Set Tracking Rate
Set Parking Position
Meridian Treatment
Set Altitude Limit
```

Select one of three available modes:

- **"Always On"** – a beep will be heard on each button operation or mount movement;
- **"On but Keyboard"** – a beep will be heard only when the mount is slewing to the object or there is a warning message;
- **"Always Off"** – all sounds will be turned off, including the SUN warning message.

### 5.4.3. Display Settings

Press **"MENU =>Settings =>Set Display"**,

```
Set Up Time and Site
Beep Settings
Display Settings
Set Guiding Rates
Set Tracking Rate
Set Parking Position
Meridian Treatment
Set Altitude Limit
```

Use the arrow keys to adjust LCD display contrast, LCD backlight intensity, and keypad's backlight intensity.

### 5.4.4. Set Guiding Rate

Press **MENU => "Settings" => "Set Guiding Rates"**,

```
Set Up Time and Site
Beep Settings
Display Settings
Set Guiding Rates
Set Tracking Rate
Set Parking Position
Meridian Treatment
Set Altitude Limit
```

This is an advanced function for autoguiding when a guiding camera is used either via a Guide Port (ST-4) or using the ASCOM protocol. Before autoguiding, align the polar axis carefully. Select an appropriate guiding speed. The latest firmware allows you to set the R.A. and DEC guiding speed differently. The R.A. guiding speed can be set between  $\pm 0.01X$  to  $\pm 0.90X$  sidereal rate. The DEC guiding speed can be set between  $\pm 0.10X$  to  $\pm 0.99X$  sidereal rate. Follow the instructions of your autoguiding software for detailed guiding operation.

The guide port wiring is shown in **Figure 4**, which has same pin-out as that from Celestron / Starlight Xpress / Orion Mount / Orion Autoguider/ QHY5 autoguider.

If you have an autoguider which has the same pin-out as the ST-I from SBIG, such as Meade/ Losmandy/ Takahashi/ Vixen, make sure a proper guiding cable is used. Refer to your guiding camera and guiding software for detailed operation.



**WARNING: DO NOT plug your ST-4 guiding camera cable into the iOptron port or HBX port. It may damage the mount or guiding camera electronics.**

#### 5.4.5. Set Tracking Rate

You can set up the mount tracking rate by selecting “**Set Tracking Rate**”.

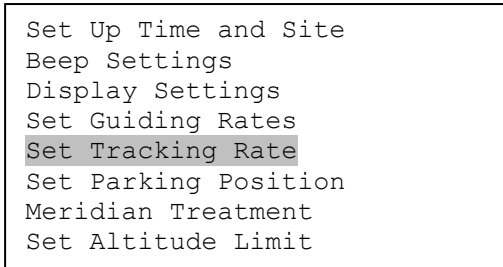

Then the user can select “**Sidereal Rate**”, “**Lunar Rate**”, “**Solar Rate**”, “**King Rate**”, and “**Custom Rate**”. The “**Custom Rate**” can be adjusted from 0.9900X to 1.0100X of sidereal.

The “**King Rate**”, developed by Edward S. King, corrects the tracking rate of a telescope to account for atmospheric refraction. This is more useful for unguided tracking.

#### 5.4.6. Set Parking Position

You may park the telescope before powering off the mount. This is very useful if the mount is on a permanent pier or the mount will not be moved in between observation sessions. The mount will keep all the alignment info and reference points.

There are six parking positions. Two positions that park the scope horizontally (**Horizon Position**). Two positions that park the scope vertically (**Zenith Position**). “**Current Position**” will park the scope at its current position. Alternatively, you can enter any altitude and azimuth combination for “**Custom Parking Pos.**”. When the mount is turned on, it will use the last parking position setting as the default setting.

#### 5.4.7. Meridian Treatment

This function tells the mount what to do when it tracks past the meridian. You can tell the mount if it needs a meridian flip and when to do it.

- “**Set Position Limit**” will tell the mount when to stop tracking or to do a meridian flip. The limit can be set at from 0° to 15° (1 hour) pass meridian for Northern Hemisphere and 0° to 10° for Southern Hemisphere.
- “**Set Behavior**” will tell the mount if a meridian flip will be performed.

#### 5.4.8. Set Altitude Limit

This function allows the mount to keep tracking an object even if it is below the horizon but can still be seen, for example from an elevated observation site, such as a hill. The range can be set from -89° to +89°. The default limit is 00°. **Be careful when setting this limit.** It may cause mount goto problems.

#### 5.4.9. Polar Scope Bright.

Use this function to adjust the light intensity of the CEM40 illuminated polar scope.

#### 5.4.10. HC Heating Switch

Turn on/off the controller LCD back heater. When “**Heating ON**” is selected, the heater will be automatically turned on when the ambient temperature reaches 0°C (32°F) and shut off at 10°C.

### 5.4.11. Set RA Guiding

The function is for the EC version of the CEM40 only. You can turn off R.A. guiding by selecting “**Filter R.A. Guiding**” to allow the high precision encoder to correct the tracking error, or turn the R.A. guiding on by selecting “**Allow RA Guiding**” to allow the mount to receive guiding corrections from the guiding software. The power on default setting is “**Allow RA Guiding**”.

### 5.4.12. Language

Select one of supported menu languages. Currently it has English and Chinese.

## 5.5. Electric Focuser

This function controls an iOptron electric focuser.

## 5.6. PEC Option

This function only works for the standard CEM40 mount.

### 5.6.1. PEC Playback

You can turn “**PEC Playback On**” to improve tracking accuracy which is especially useful for long exposure astrophotography. The default status is “**PEC Playback Off**” when the mount is turned on.

### 5.6.2. Record PEC

All equatorial mounts have a small variation in the worm gears which may be corrected by using Period Error Correction or PEC. PEC is a system which improves the tracking accuracy of the mount by compensating for variations in the worm gear and is especially useful when doing astrophotography without autoguiding. Because the variations are regular, it is possible to record the corrections required to cancel out the worm gear variations and to play them back to correct the periodic error caused by the variations.

In order to use the PEC function, the Go2Nova<sup>®</sup> hand controller first needs to record the periodic error. The periodic error of the worm gear drive will be used to correct periodic error.

To use the PEC function:

1. Setup the mount with a telescope in autoguiding configuration by connecting a guiding camera via the mount's Guide Port or using the ASCOM protocol;
2. Select “**MENU=>Settings => Set Guiding Rates**”. Set a guiding speed from 0.10X to 0.90X. The default setting is 0.50X;
3. Then press the **BACK** button and select “**PEC Option**” from the menu. Use the **▲** and **▼** scroll buttons to display the “**Record PEC**” option and press **ENTER** to start recording the periodic error.
4. It takes the worm gear 400 seconds to make one complete revolution. After 400 seconds PEC will automatically stop recording. The PEC value will be permanently stored inside PEC chip on R.A. motor drive until a new data are recorded.
5. If you want to re-record the periodic error, select “**Record PEC**” and repeat the recording processes again. The previously recorded information will be replaced with the current information.

### 5.6.3. PEC Data Integrity

This function will check the recorded PEC data integrity.

## 5.7. Park Telescope

This function parks the scope to one of four preset park positions.

## 5.8. Edit User Objects

Besides various star lists available in the hand controller, you can add, edit or delete your own user-defined objects. This is especially useful for newly found comets. You can also add your favorite observation object into the user object list for easy sky surfing. Up to 60 comets and other user objects can be stored.

### 5.8.1. Enter a New Comet

Press “**MENU =>Edit User Objects**” to set user objects.

```
User Defined Comet
Other Objects
```

Select “**User Defined Comet**” to add/browse/delete the user-defined comet list. Find the orbit parameters of a comet in the SkyMap format. For example, the C/2012 ISON has an orbit parameter:

No.	Name	Year	M	Day	q	e	$\omega$	$\Omega$	I	H	G
C/2012	S1 ISON	2013	11	28.7960	0.0125050	1.0000030	345.5088	295.7379	61.8570	6.0	4.0

Select “**Add a New Comet**” to add a new one:

```
Add a New Comet
Browse Comets
Delete a Comet
Delete All Comets
```

The hand controller will display the parameter entry screen:

```
Enter Comet Parameter
Date: 0000-00-00.0000
q: 0.000000
e: 0.000000
 $\omega$ : 000.0000
 $\Omega$ : 000.0000
i: 000.0000
```

Enter the parameters using the arrow buttons and number keys. Press **ENTER** and a confirmation screen will be displayed. Press **ENTER** again to store the object under the assigned user object number, or press **BACK** button to cancel.

### 5.8.2. Enter Other Objects or Observation List

Press “**MENU =>Edit User Objects**” to set user objects.

```
User Defined Comet
Other Objects
```

Select “**Other Objects**” to enter you own object:

```
Add a New Object
Browse Objects
Delete One Object
Delete All Objects
```

Select “**Add a New Object**”. A screen will be displayed asking you to **Enter R.A. and DEC coordinates**:

```
Enter R.A. and DEC
R.A.: 00h00m00s
DEC: +00d00m00s
```

You may enter the R.A. and DEC coordinates of the object you want to store, and press **ENTER** to confirm.

A more useful application of this function is to store your favorite viewing objects before heading to the field. When the “**Enter R.A. and DEC**” screen appears, press the **MENU** button. It brings up the catalogs that you can select the object from. Follow the screen instructions to add your favorite objects. Press **BACK** button to go back one level.

Press the **BACK** button to go back to the object entry submenu. You may review the records or delete those that are no longer wanted. Press the **BACK** button to finish the operation. Now you can slew to your favorite stars from “**Custom Objects**” catalog using “**Select and Slew.**”

## **5.9. Firmware Information**

This option will display the mount type, firmware version information for the hand controller (HC), Main board (Main), R.A. board (RA), DEC board (DEC) and star catalog.

## **5.10. Zero Position**

### **5.10.1. Goto Zero Position**

This moves your telescope to its Zero Position.

### **5.10.2. Set Zero Position**

This set the Zero Position for the firmware.

The Zero Position reference will be an undefined value after firmware upgrade, or it may lost during power outage or HC battery replacement. You can use this function to set the zero position reference.

Press the **ENTER** after moving the mount to Zero Position either manually or with the hand controller.

### **5.10.3. Search Zero Pos.**

In the event of power failure, the mount will lose all its alignment information. This can be very troublesome if the mount is being operated from a remote observation site and is controlled via the internet. To counter this, the CEM40 has been equipped with a function that can find the Zero Position for an initial mount set up.

Select “**Search Zero Pos.**” and the mount will start to slew slowly and find the R.A. and DEC position to set the mount to the Zero Position. When the mount has found the Zero Position, the HC will ask if you want to calibrate the Zero Position. Press **ENTER** to confirm. Use the arrow button to adjust the mount in RA and DEC to correct the obvious discrepancy in the Zero Position. Alternatively, press **BACK** to cancel.



## 6. Maintenance and Servicing

### 6.1. Maintenance

The CEM40 mount is designed to be maintenance free. Do not overload the mount. Do not drop the mount as this will damage the mount and / or permanently degrade GoTo performance and tracking accuracy. Use a wet cloth to clean the mount and hand controller. Do not use solvent.

If your mount is not to be used for an extended period, dismount the OTAs and counterweight(s).

### 6.2. iOptron Customer Service

If you have any question concerning your CEM40 mount contact iOptron Customer Service Department. Customer Service hours are from 9:00 AM to 5:00 PM, Eastern Time, Monday through Friday. In the event that the CEM40 requires factory servicing or repairing, write or call iOptron Customer Service Department first to receive an RMA# before returning the mount to the factory. Please provide details as to the nature of the problem as well as your name, address, e-mail address, purchase information and daytime telephone number. We have found that most problems can be resolved by e-mails or telephone calls, so please contact iOptron first to avoid returning the mount for repair.

It is strongly suggested that to send technical questions to [support@ioptron.com](mailto:support@ioptron.com). Call in the U.S. 1.781.569.0200.

### 6.3. Product End of Life Disposal Instructions



This electronic product is subject to disposal and recycling regulations that vary by country and region. It is your responsibility to recycle your electronic equipment per your local environmental laws and regulations to ensure that it will be recycled in a manner that protects human health and the environment. To find out where you can drop off your waste equipment for recycling, please contact your local waste recycle/disposal service or the product representative.

### 6.4. Battery Replacement and Disposal Instructions



Battery Disposal: Batteries contain chemicals that, if released, may affect the environment and human health. Batteries should be collected separately for recycling, and recycled at a local hazardous material disposal location adhering to your country and local government regulations. To find out where you can drop off your waste battery for recycling, please contact your local waste disposal service or the product representative.

## Appendix A. Technical Specifications

Mount	Center-balanced Equatorial Mount (CEM)
Max payload*	40 lb (18kg), exclude counterweight
Mount weight	15.8 lb (7.2kg)
Payload/Mount weight ratio	2.5:1
Structure Material	All metal, CNC machined
Exterior finish	Anodized red/black
Latitude adjustment range	0°~ 60° (special CW shaft mounting if <10° )
Azimuth adjustment range	± 6°
Right Ascension worm wheel	Φ110mm, 216 teeth aluminum
Declination worm wheel	Φ110mm, 216 teeth aluminum
PEC	PPEC/Real time PEC
Tracking accuracy (PE)**	<±7 arcsec p-p (#7400A), or <0.25 arcsec RMS for 400sec (#7400ECA)
Counterweight shaft	Φ20x 410 mm Stainless Steel (1kg)
Counterweight	10 lb (4.5 kg)
Mount base size	Φ120 mm
Motor drive	Precision stepper motor, 1.8°/128X micro-step
Motor resolution	0.08 arc seconds
Slew speed	1×,2×,8×,16×,64×,128×,256×,512×,MAX(~4.5°/sec)
Power consumption	0.6A(Tracking), 0.9A(GOTO)
Power requirement	12V DC 5A
AC adapter	100V ~ 240V (included)
Polar Scope	Internal iPolar™ electronic polar scope
Level indicator	Level bubble
Dovetail saddle	iOptron Universal Saddle, 5"
Hand Controller	Go2Nova® 8407+, 212,000 objects database, star recognition
Meridian treatment	Stop (0-14° pass), auto flip
GPS	Yes
WIFI	External (optional)
Autoguide port	ST-4
Communication port	USB Port (on mount)
PC computer control	Yes (ASCOM)
Cable management	USB2.0, DC12V (MAX 3A), ST4
Operation temperature	-10°C ~ +40°C
Tripod	1.5" Stainless Steel(5kg), optional 2" or tri-pier
Warranty	Two year limited

\* OTA size and length dependent

\*\* Measured with encoder, 400 seconds

# Appendix B. Go2Nova<sup>®</sup> 8407+ HC MENU STRUCTURE

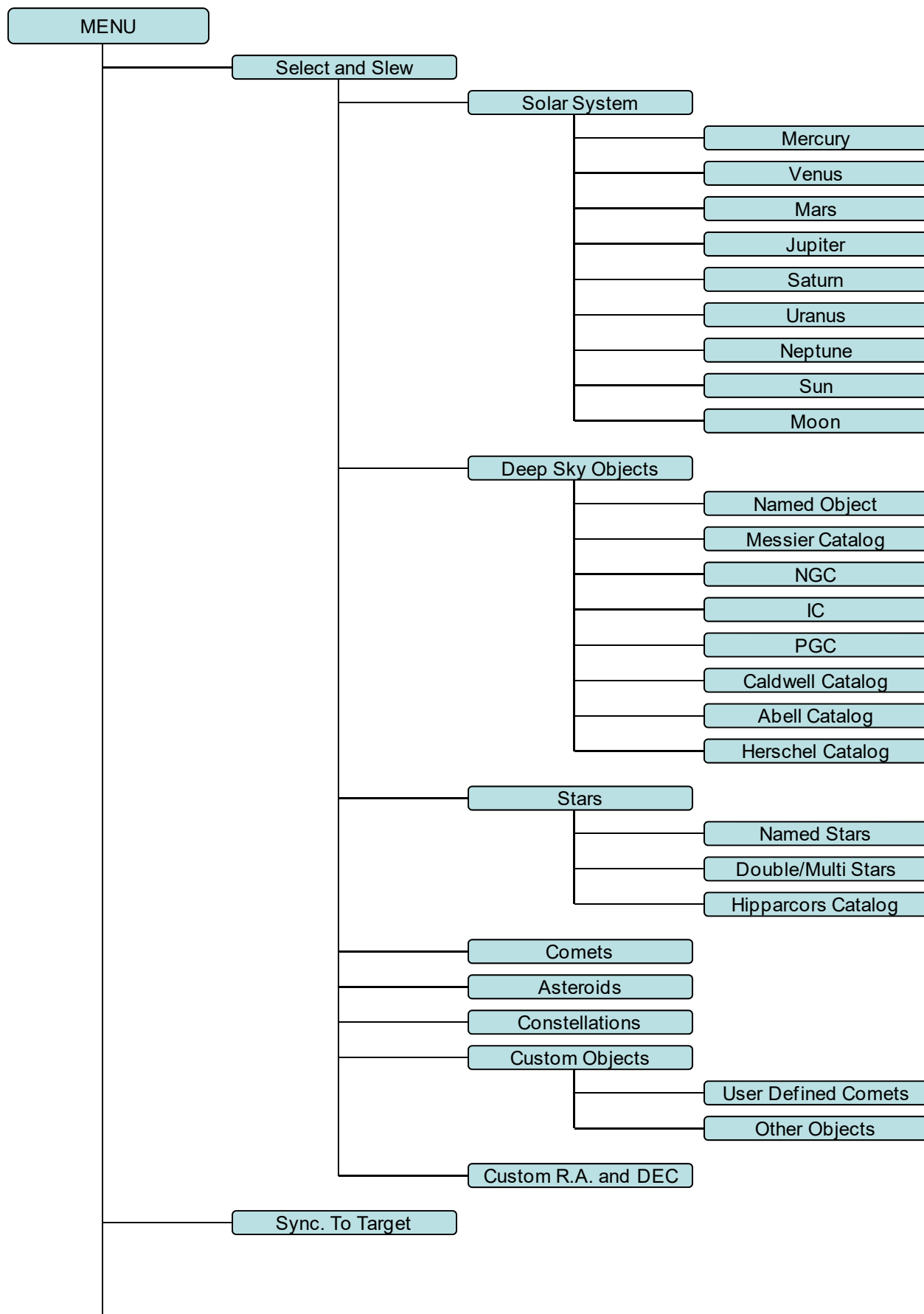

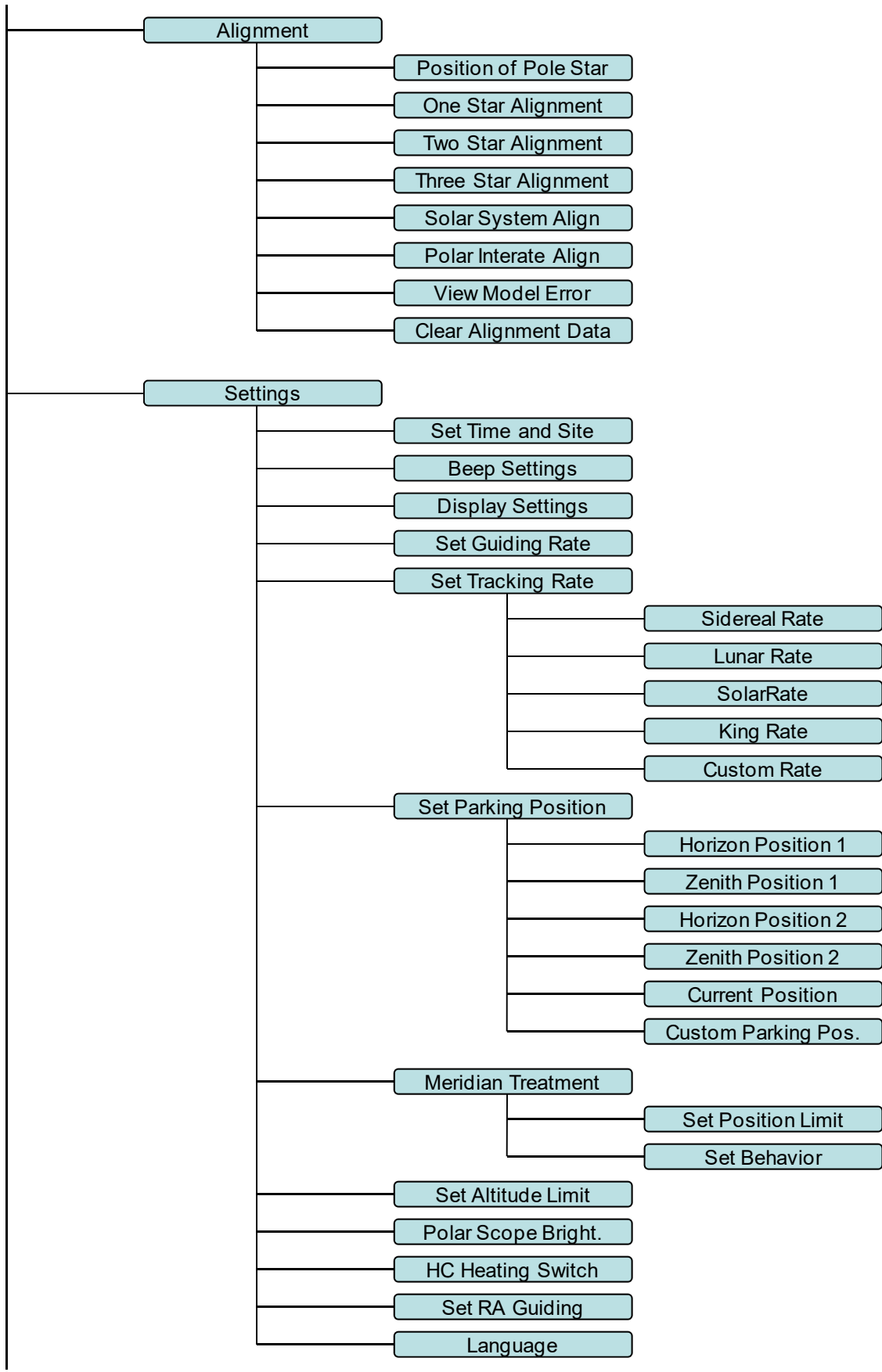

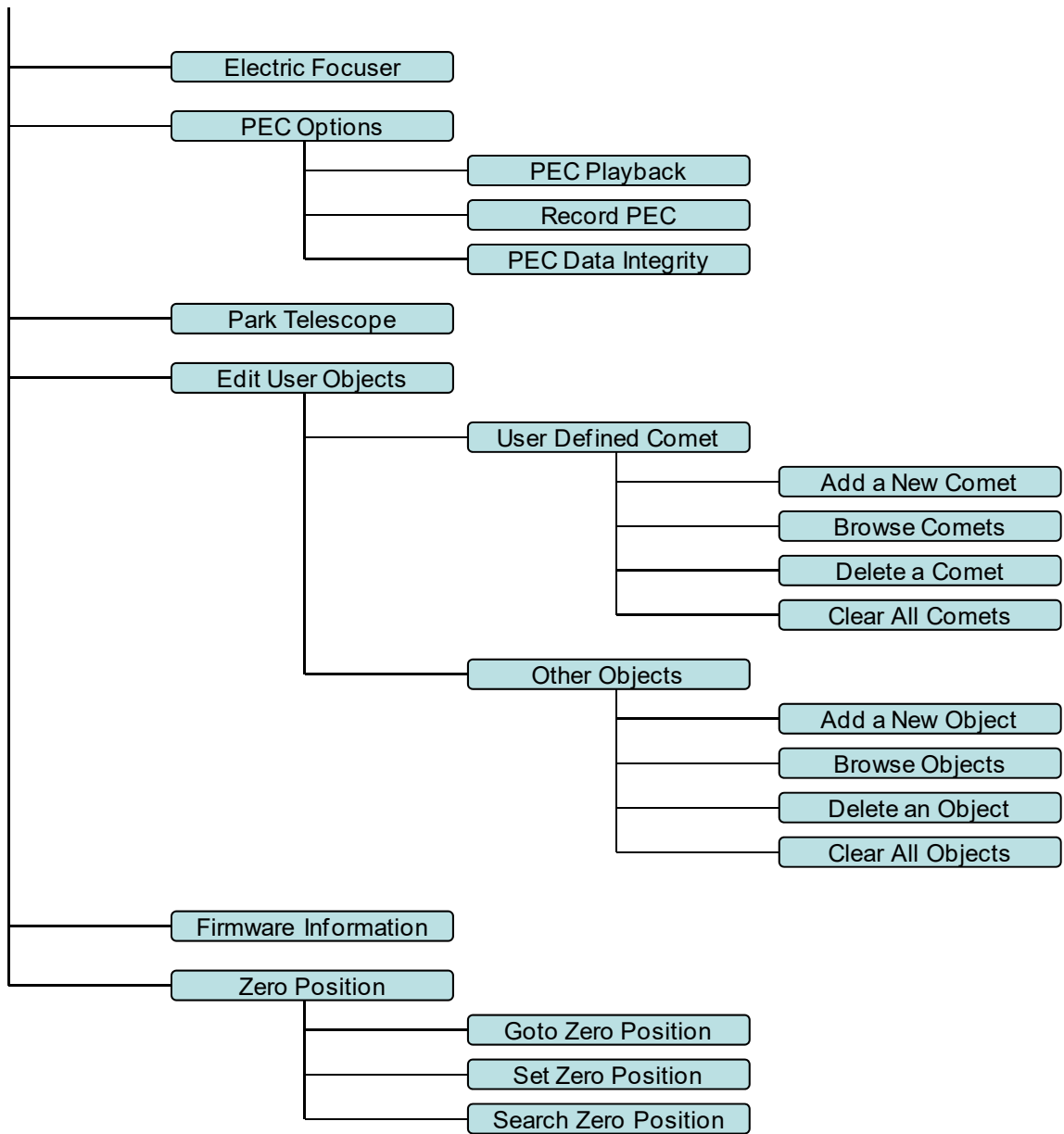

# Appendix C. Polar Alignment using iPolar Electronic PolarScope

Please refer to iPolar (#3399) product page for latest update.

## 1. Connect iPolar to a PC and Download iPolar Software

- (1) Connect the iPolar Electronic PolarScope to your PC USB port;
- (2) The iPolar driver will be automatically installed if it is the first time connecting to the computer;
- (3) You should see "iOptron iPolar" under Camera catalog in computer Device Manager;
- (4) Goto [www.ioptron.com](http://www.ioptron.com) to download iPolar software and save on your computer;
- (5) The iPolar software needs Windows Vista, 7, 8, 8.1, 10 or later version, 32 bit or 64 bit operation system, with .NET Framework 4.6 or later version.

## 2. Polar Alignment

### Step 1: Adjust CEM40 Pointing Direction

Set the counterweight shaft at the lowest point. Adjust the altitude to you latitude. Point the mount to true north (or true south if located in southern hemisphere).

### Step 2. Initialization iPolar

- (1) Run downloaded iPolar software to bring up the polar alignment main menu;
- (2) Click on "**Connect**" button to connect the iPolar to the computer. The software will start to initialize the process the camera is connected successfully. If it fails to connect, check the cable and try it again.

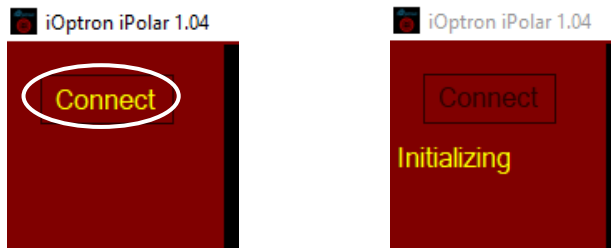

- (3) If this is the first time to use iPolar, a dark frame image of the camera needs be taken. Click on **Settings** to bring up **Settings Menu**:

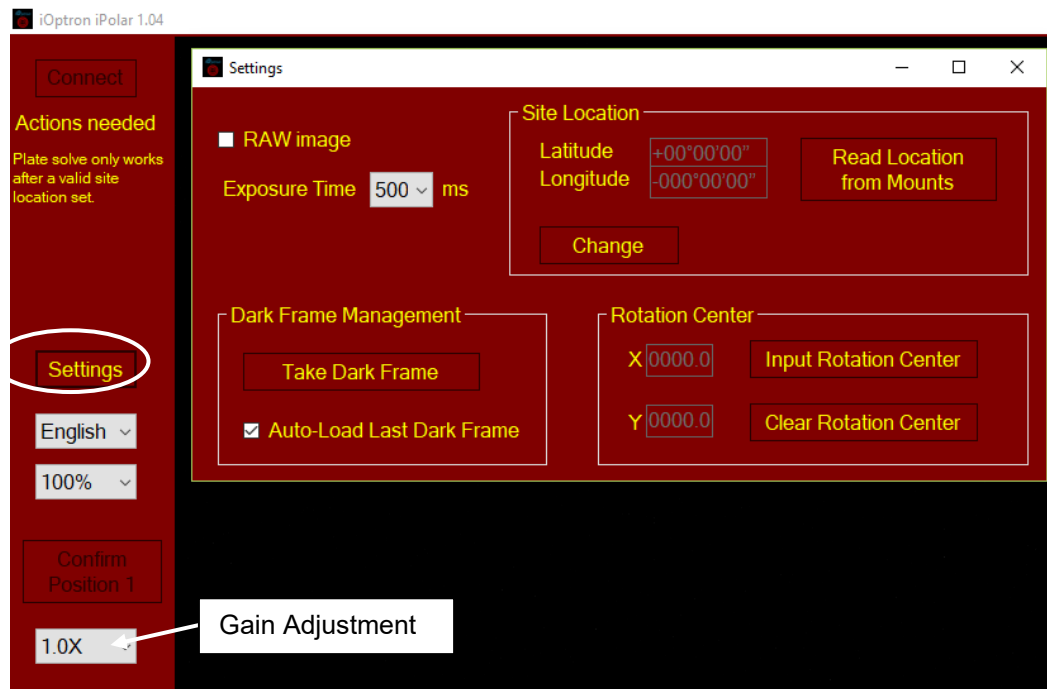

- (4) Adjust **Exposure Time** and **Gain** (from 1.0X pull down menu in main display menu) to obtain a sky image with clear stars displayed;
- (5) Click on **Take Dark Frame**;
- (6) Follow the on screen instruction to cover the camera, finish taking dark frame and uncover the camera;
- (7) You may check the **Auto-Load Last Dark Frame** for next time use. Close Setting Menu.

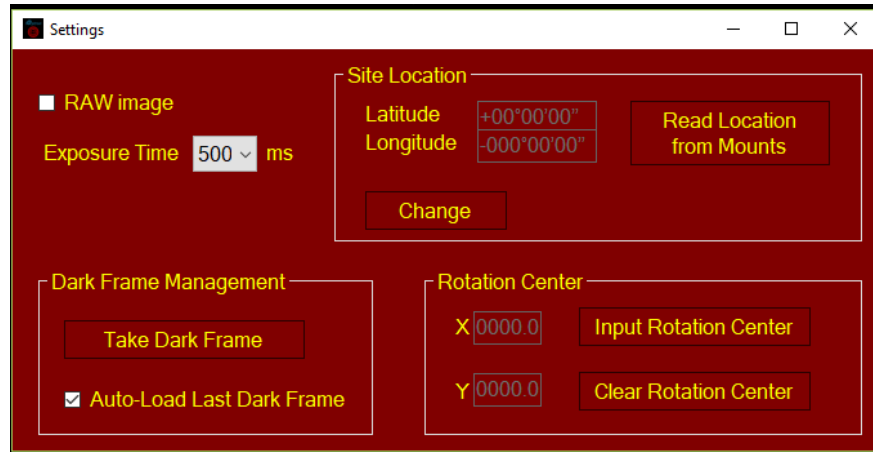

### Step 3. Set Location

There are two ways to set your observing location info:

#### Enter Manually

- (1) Click on **Settings**;
- (2) Click on **Change**

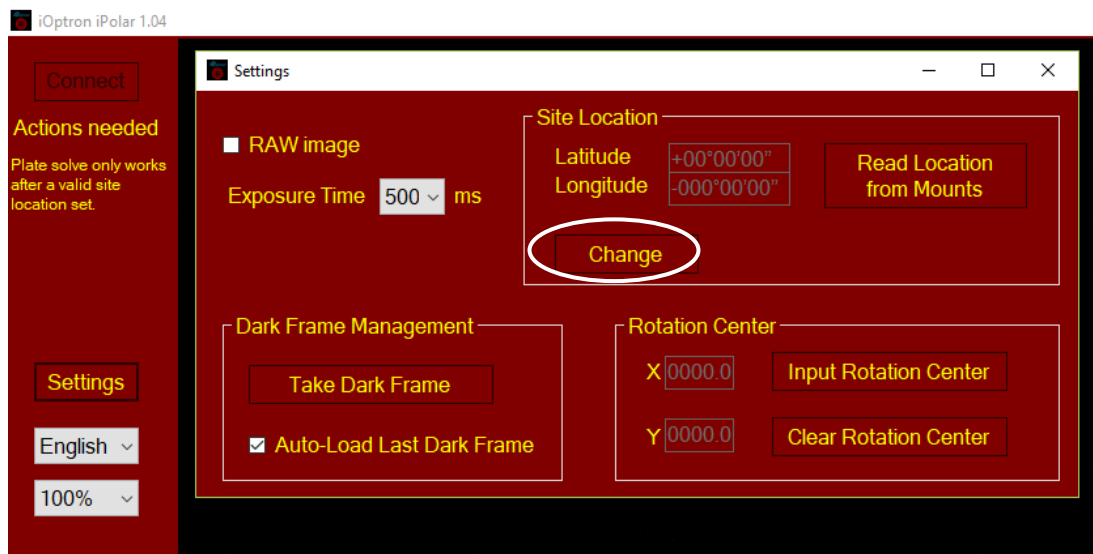

- (3) Enter your latitude and longitude numbers:

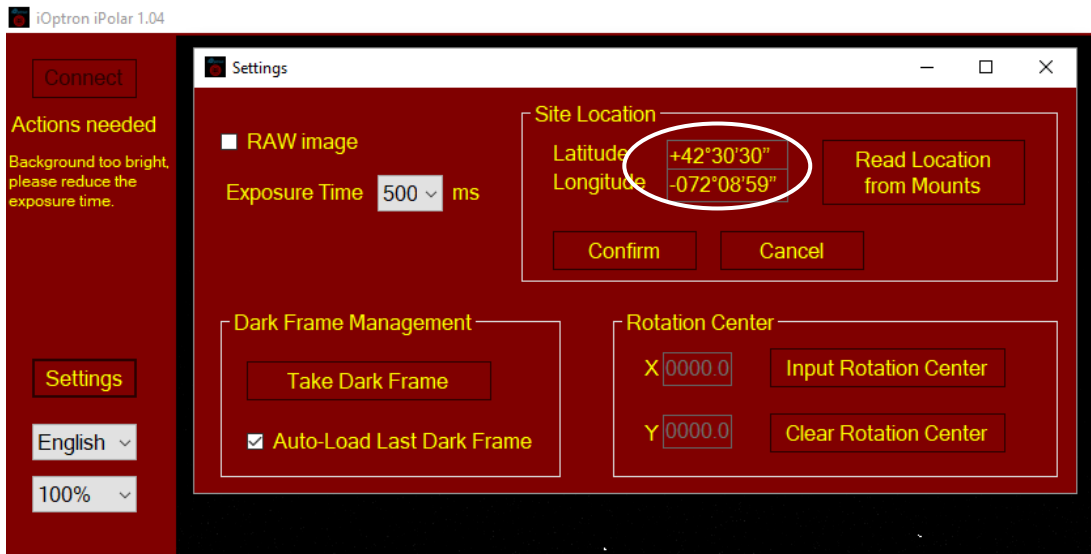

(4) Click **Confirm** to complete the location setting.

### **Read from an ASCOM Supported Mount**

- (1) Click on **Settings**;
- (2) Click on **Read Location from Mounts**

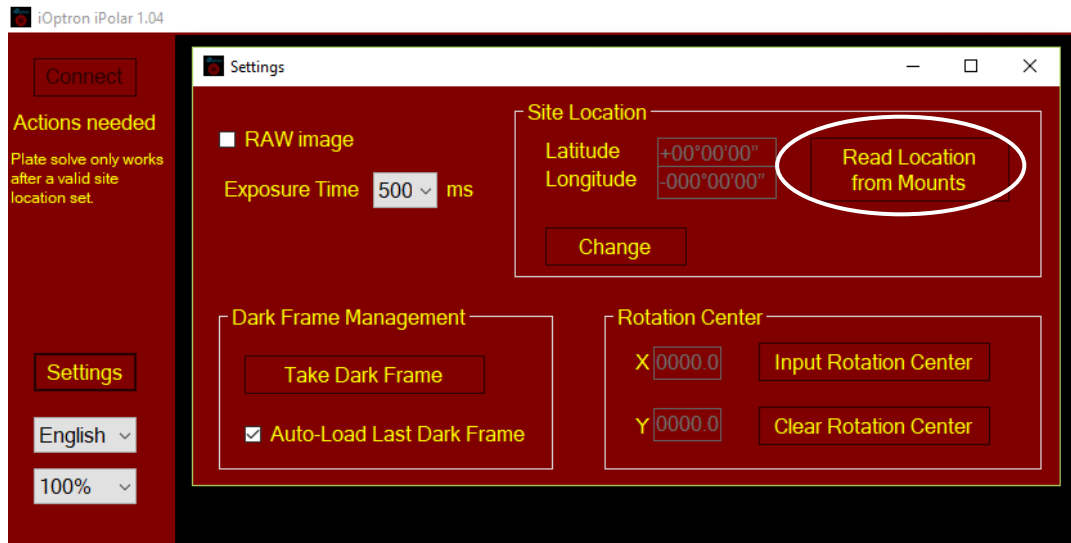

(3) An ASCOM Telescope Chooser window will occur. Choose “**iOptron ASCOM Driver for Mount**” from the pull-down menu and click OK.



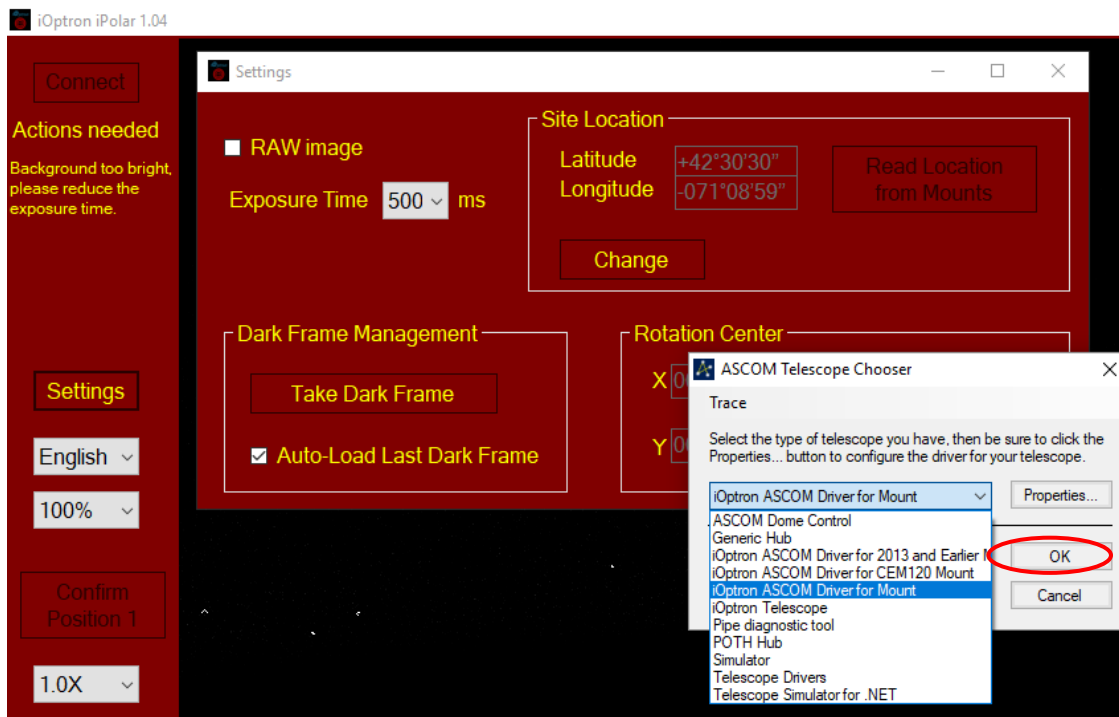

(4) Click **OK** to complete the location setting.

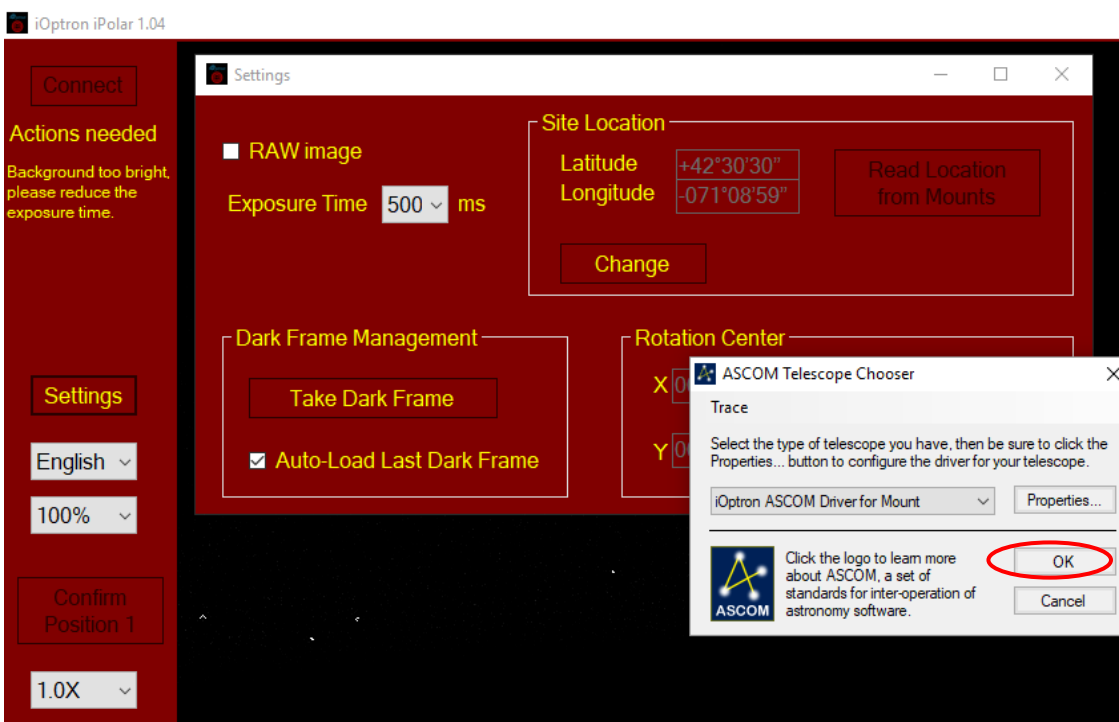

#### Step 4. Plate Solving and Polar Alignment

If the iPolar has been calibrated (see **Section 3** below for calibration), there will be a bright red cross on the screen, which is the polar scope/mount RA axis rotating center. The alignment software will perform plate solving near the pole star area. There is no need to see the pole star, nor a crystal clear night sky.

When the camera can see more than 4 stars, it will take the images, enhance the star and darken the background, remove the noise and plate solving the area. It will display the pole with a dark read dot.

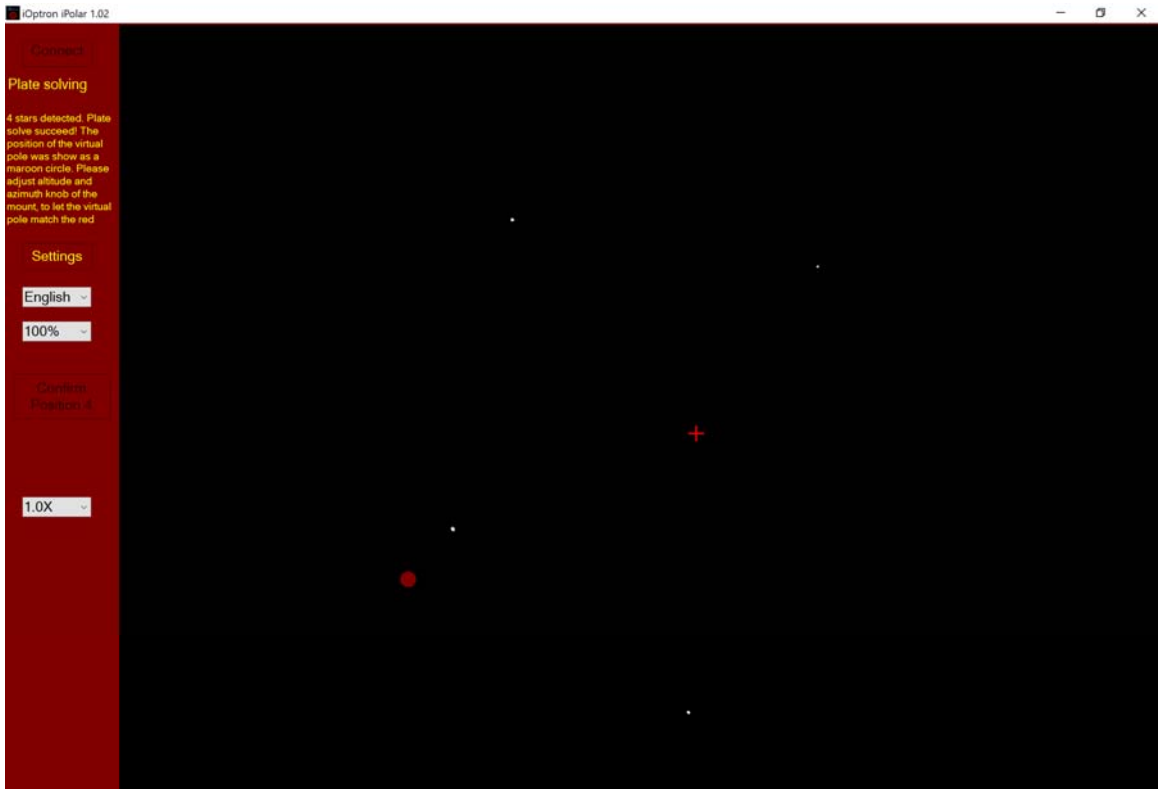

Adjust the altitude and azimuth screws to move the read dot towards read cross. The image will be enlarged when they are moving close.

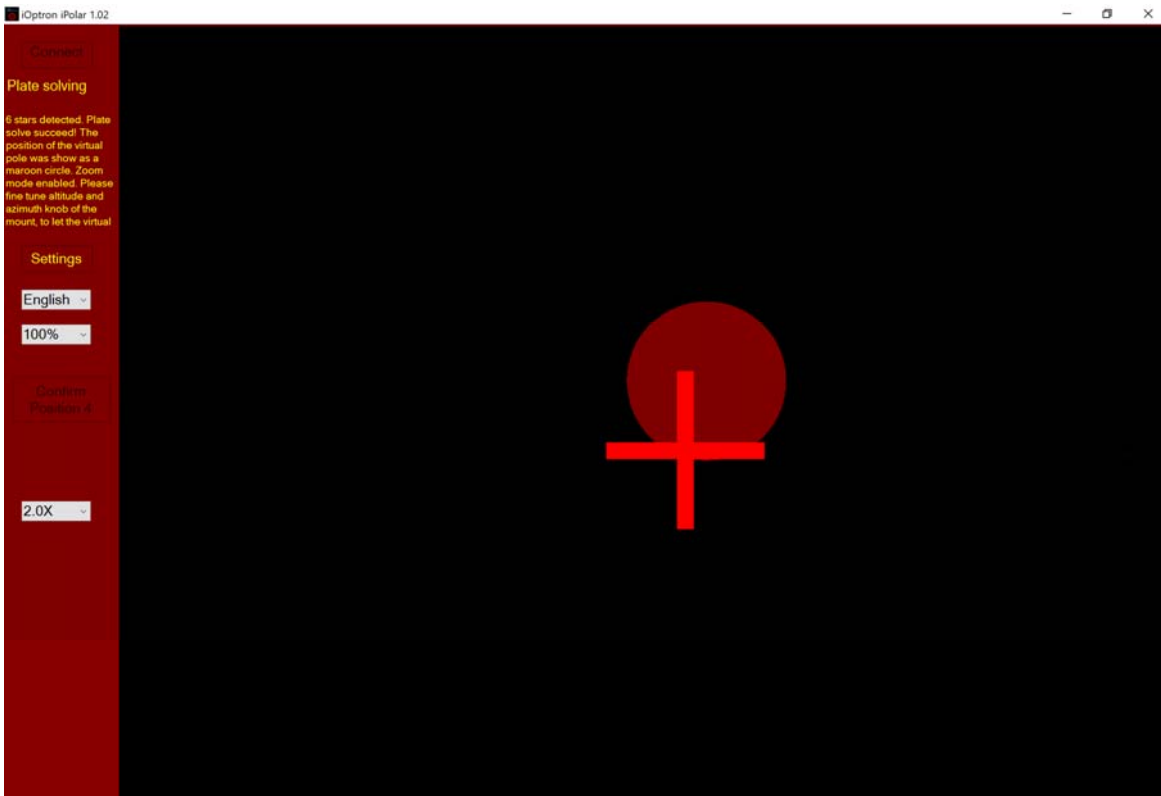

When read dot fully covers red cross, the pole alignment is done.

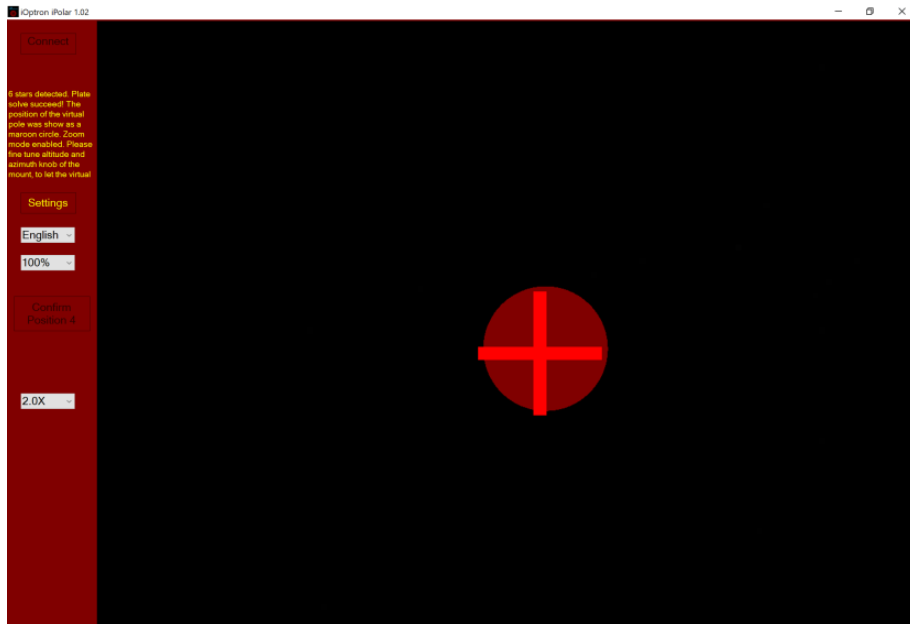

**NOTE:** You can click on **Settings** and check **RAW** to see the real sky image at any time. Please **uncheck** RAW during polar alignment for better results.

### 3. iPolar Calibration

If do not see the red cross on the screen, the iPolar has not been calibrated. Calibration is only needed after iPolar is installed or any mechanical adjustment has been done on iPolar.

Rotate the RA axis of the mount roughly to the following three positions. Click on **Confirm Position 1**, **Confirm Position 2** and **Confirm Position 3**, respectively, to complete the calibration.

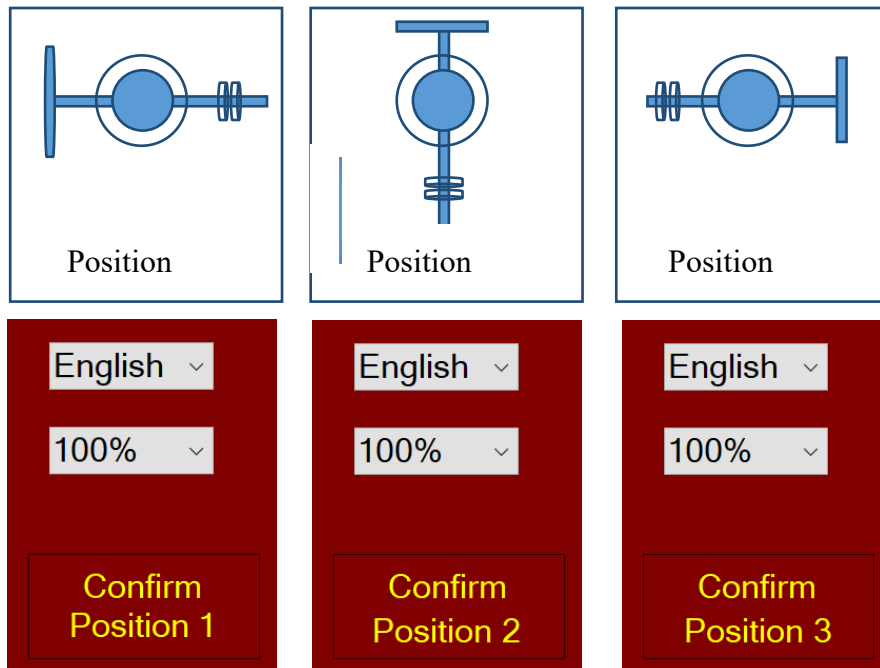

**Note:** If the software does not bring up Confirm Position 2, the initial RA axis is too aloes to the pole axis. Just move the mount away a bit in altitude or azimuth direction and try it again.

## Appendix D. Gear Meshing Adjustment

CEM40 gear is designed adjustable by customer although in most cases not necessary. If you experienced DEC/RA motor stall occasionally, or there is free play between the worm and gear, follow this instruction to adjust the gear meshing.

**Tool needed:** 2mm and 3mm hex keys.

### To Adjust DEC Gear:

Disengage DEC gear switch



Rotate DEC saddle to exposure the small hole (3mm in diameter) that is blocked by the dovetail saddle. Another larger hole (5mm) is located on the side of the DEC gear housing. There is a **set screw** inside the 3mm hole which locks the **gear meshing adjustment screw**, which is inside the larger hole.

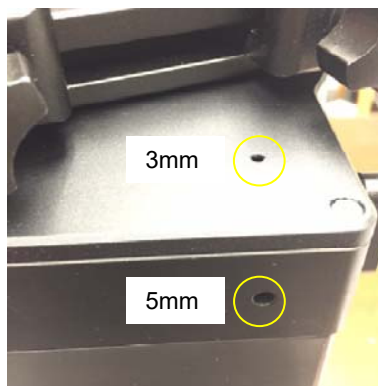

Engage the worm/gear by turn the gear switch to locking position.

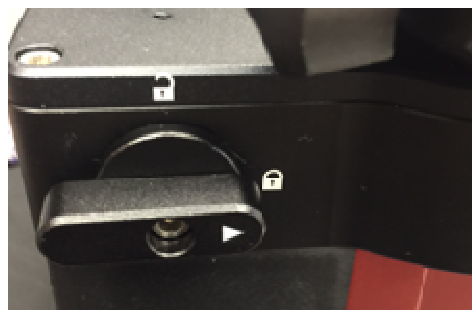

Insert the 2mm hex key into the small hole on the top. Gently turn the hex key until you feel it is engaged to the set screw inside. You may turn the gear switch further in the lock position if the wrench can't engage the set screw. Turn the **set screw** half a turn counterclockwise to release it.

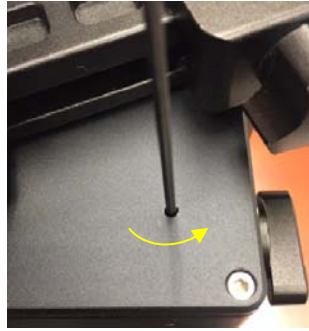

Adjust the **gear adjustment screw** on the side inside the large hole by using the 3mm hex key. Turn counterclockwise to loosen the meshing or turn clockwise to tighten the meshing.

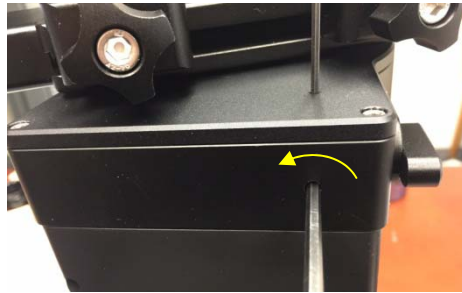

If the motor stalls or the mount does not tracking smoothly, most likely the meshing is too tight. You may loosen it by about 1/8 turn (or less for tracking). **Tighten the set screw in the small hole to LOCK the gear screw (important) before test the mount.** Adjust again if needed, but no more than 1/4 turn in total.

If you feel there is free play between the worm and gear, you may tighten the gear screw to eliminate it.

### **To Adjust RA Gear:**

The RA gear meshing adjustment screw is located next to the RA Gear Switch. The adjustment is same as that for DEC gear/worm.

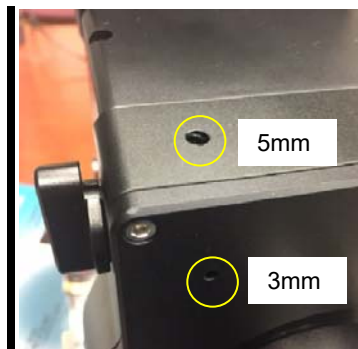

Please contact [support@ioptron.com](mailto:support@ioptron.com) if you need more information.

## **Appendix E. Firmware Upgrade**

The firmware in the 8407+ Hand Controller and control boards can be upgraded by the customer. Please check iOptron's website, [www.iOptron.com](http://www.iOptron.com), under Support Documents of the CEM40 product page.

The mount firmware is upgraded via USB port on the mount. The hand controller firmware is upgraded via RS232 port on HC.

## Appendix F. Computer Control a CEM40 Mount

The CEM40 mount can be controlled by a SmartPhone, a tablet or a computer. It is supported by two types of computer connections:

- Connect to a computer via USB port on the mount using a USB cable. You may need to install a FTDI USB to RS232 VCP driver (<https://www.ftdichip.com/Drivers/VCP.htm>). The mount can be controlled via ASCOM protocol (Windows OS), or directly by some software, such as Sky Safari (Mac OS).
- Connect wirelessly with iOptron iStarFi adapter for CEM40 (#7434). The mount can be controlled via ASCOM protocol (Windows OS), SmartPhone/Pad and Mac OS wirelessly. See iStarFi Instruction Manual for detailed information.

To control the mount via ASCOM protocol, you need:

1. Download and install the latest ASCOM Platform, currently 6.4 SP1, from <http://www.ascom-standards.org/>. Make sure your PC meets the software requirement.
2. Download and install the latest iOptron Telescope ASCOM/Commander for CEM40 from iOptron website.
3. Planetarium software that supports ASCOM protocol. Follow software instructions to select the iOptron Telescope.

Please refer to iOptron website, [www.iOptron.com](http://www.iOptron.com), under Support Directory/ASCOM Driver, iOptron Telescope ASCOM Driver, for more detail.

## Appendix G. Go2Nova<sup>®</sup> Star List

### Named Deep Sky Object

1	47 Tucanae	47	Integral Sign Galaxy
2	Andromeda Galaxy	48	Iris Nebula
3	Antennae Galaxies	49	Jellyfish Nebula
4	Barnard's Galaxy	50	Jewel Box Cluster
5	Bear-Paw Galaxy	51	Lagoon Nebula
6	Beehive Cluster	52	Lambda Centauri Nebula
7	Black Eye Galaxy	53	Large Magellanic Cloud
8	Blinking Planetary	54	Leo Triplet
9	Blue Flash Nebula	55	Little Dumbbell Nebula
10	Blue Planetary	56	Little Gem Nebula
11	Blue Snowball Nebula	57	Little Ghost Nebula
12	Bode's Galaxy	58	Mice Galaxies
13	Box Nebula	59	Monkey Head Nebula
14	Bubble Nebula	60	North America Nebula
15	Bug Nebula	61	Northern Jewel Box
16	Butterfly Cluster	62	Omega Nebula
17	Butterfly Galaxies	63	Orion Nebula
18	California Nebula	64	Owl Nebula
19	Carina Nebula	65	Pacman Nebula
20	Cat's Eye Nebula	66	Pelican Nebula
21	Cave Nebula	67	Phantom Streak Nebula
22	Christmas Tree Cluster	68	Pinwheel Galaxy
23	Cigar Galaxy	69	Pleiades
24	Cocoon Nebula	70	Ring Nebula
25	Coma Pinwheel	71	Rosette Nebula
26	Copeland Septet	72	Saturn Nebula
27	Crab Nebula	73	Sextans B
28	Crescent Nebula	74	Small Magellanic Cloud
29	Draco Dwarf Galaxy	75	Sombrero Galaxy
30	Dumbbell Nebula	76	Soul Nebula
31	Eagle Nebula	77	Southern Pinwheel Galaxy
32	Eight-Burst Nebula	78	Spindle Galaxy(3115)
33	Elephant Trunk Nebula	79	Spindle Galaxy(5866)
34	Eskimo Nebula	80	Stephan's Quintet
35	Eyes Galaxies	81	Sunflower Galaxy
36	Flame Nebula	82	Tarantula Nebula
37	Flaming Star Nebula	83	The Witch Head Nebula
38	Ghost of Jupiter	84	The Wizard Nebula
39	Heart Nebula	85	Thor's Helmet
40	Helix Nebula	86	Triangulum Galaxy
41	Hercules Globular Cluster	87	Trifid Nebula
42	Hind's Variable Nebula	88	Ursa Minor Dwarf Galaxy
43	Hockey Stick Galaxies	89	Veil Nebula
44	Horsehead Nebula	90	Whale Galaxy
45	Hubble's Variable Nebula	91	Whirlpool Galaxy
46	Hyades Cluster	92	Wild Duck Cluster



# Messier Catalog

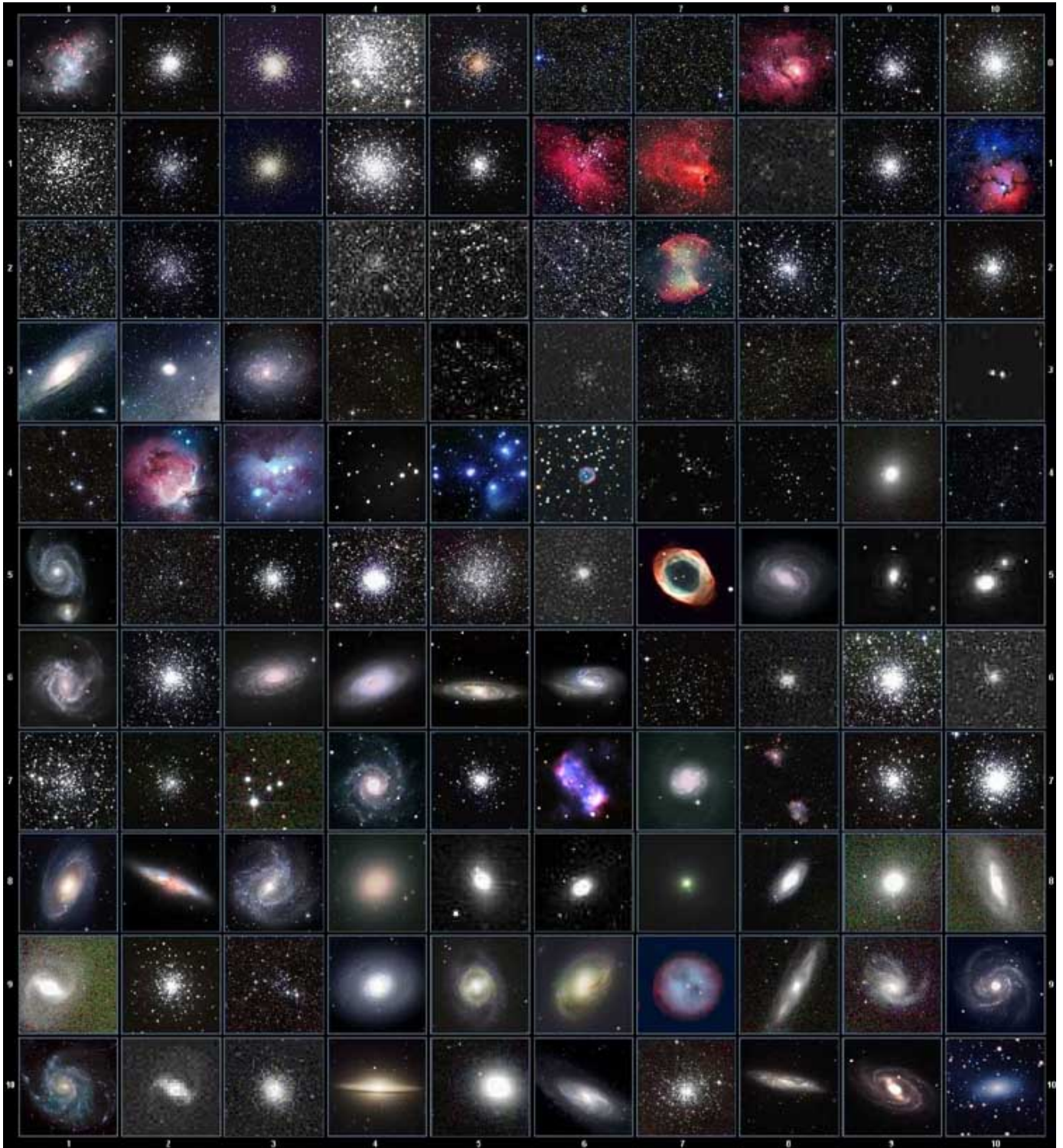

This table is licensed under the [GNU Free Documentation License](#). It uses material from the [Wikipedia article List of Messier objects](#)

## Named Stars

1	Acamar	50	Alrescha	99	Deneb el Okab	148	Lalande 21185
2	Achernar	51	Alshain	100	Deneb Kaitos	149	Lesath
3	Achird	52	Altair	101	Denebakrab	150	Mahasim
4	Acrab	53	Altais	102	Denebola	151	Maia
5	Acrux A	54	Alterf	103	Dschubba	152	Marfik
6	Acrux B	55	Aludra	104	Dubhe	153	Marfikent
7	Acubens	56	Alula Australis	105	Edasich	154	Markab
8	Adhafera	57	Alula Borealis	106	El Rehla	155	Markeb
9	Adhara	58	Alya	107	Electra	156	Matar
10	Adid Australis	59	Ancha	108	Elnath	157	Mebсутa
11	Ahadi	60	Ankaa	109	Eltanin	158	Megrez
12	Al Dhanab	61	Antares	110	Enif	159	Meissa
13	Al Dhibain Prior	62	Apollyon	111	Errai	160	Mekbuda
14	Al Kab	63	Arcturus	112	Fomalhaut	161	Menkalinan
15	Al Nair	64	Arkab Prior	113	Furud	162	Menkar
16	Al Nair al Baten	65	Arneb	114	Gacrux	163	Menkent
17	Al Niyat(Sigma)	66	Ascella	115	Gatria	164	Menkib
18	Al Niyat(Tau)	67	Asellus Austr	116	Giausar	165	Merak
19	Albaldah	68	Asellus Boreali	117	Gienah Corvi	166	Merope
20	Albali	69	Aspidiske	118	Gienah Cygni	167	Mesartim
21	Albireo	70	Atik	119	Girtab	168	Miaplacidus
22	Alchiba	71	Atlas	120	Gliese 1	169	Mimosa
23	Alcor	72	Atria	121	Gomeisa	170	Mintaka
24	Alcyone	73	Avior	122	Graffias(Zeta)	171	Mira
25	Aldebaran	74	Azha	123	Groombridge 1830	172	Mirach
26	Alderamin	75	Barnard's Star	124	Gruid	173	Mirfak
27	Alfirk	76	Baten Kaitos	125	Grumium	174	Mirzam
28	Algenib	77	Beid	126	Hadar	175	Mizar
29	Algenubi	78	Bellatrix	127	Hamal	176	Mu Velorum
30	Algieba	79	Beta Hydri	128	Han	177	Muhlifain
31	Algiedi Secunda	80	Betelgeuse	129	Hatsya	178	Muphrid
32	Algol	81	Betria	130	Head of Hydrus	179	Muscida
33	Algorab	82	Biham	131	Homam	180	Naos
34	Alhakim	83	Birdun	132	Iritjinga(Cen)	181	Nashira
35	Alhena	84	Canopus	133	Izar	182	Navi
36	Alioth	85	Capella	134	Kakkab Su-gub Gud-Elim	183	Nekkar
37	Alkaid	86	Caph	135	Kapteyn's Star	184	Nihal
38	Alkalurops	87	Castor A	136	Kaus Australis	185	Nunki
39	Alkes	88	Castor B	137	Kaus Borealis	186	Nusakan
40	Almaaz	89	Cebalrai	138	Kaus Media	187	Palida
41	Almach	90	Chara	139	Keid	188	Peacock
42	Alnasl	91	Chertan	140	Kekouan	189	Phact
43	Alnilam	92	Choo	141	Kitalpha	190	Phecda
44	Alnitak	93	Cor Caroli	142	Kochab	191	Pherkad
45	Alpha Muscae	94	Cursa	143	Koo She	192	Polaris
46	Alpha Tucanae	95	Dabih	144	Kornephoros	193	Pollux
47	Alphard	96	Deltotum	145	Kraz	194	Porrima
48	Alphecca	97	Deneb	146	Kurhah	195	Procyon
49	Alpheratz	98	Deneb Algedi	147	Lacaille 9352	196	Propus

197	Proxima Centauri	213	Sadalbari	229	Sulafat	245	Vindemiatrix
198	Rasalas	214	Sadalmelik	230	Syrma	246	Vrischika
199	Rasalgethi	215	Sadalsuud	231	Talitha	247	Wasat
200	Rasalhague	216	Sadr	232	Tania Australis	248	Wazn
201	Rastaban	217	Saiph	233	Tania Borealis	249	Wei
202	Regor	218	Sargas	234	Tarazed	250	Wezen
203	Regulus	219	Scheat	235	Taygeta	251	Yed Posterior
204	Rigel	220	Schedar	236	Tejat Posterior	252	Yed Prior
205	Rigel Kentaurus A	221	Seginus	237	Thuban	253	Zaniah
206	Rigel Kentaurus B	222	Shaula	238	Thusia	254	Zaurak
207	Ruchbah	223	Sheliak	239	Tien Kwan	255	Zavijava
208	Rukbat	224	Sheratan	240	Turais	256	Zeta Persei
209	Rukh	225	Sirius	241	Unukalhai	257	Zosma
210	Rutilicus	226	Skat	242	Vasat-ul-cemre	258	Zubenelgenubi
211	Sabik	227	Spica	243	Vathorz Posterior	259	Zubeneschamali
212	Sadachbia	228	Suhail	244	Vega		

## Modern Constellations

No.	Constellation	Abbreviation
1	Andromeda	And
2	Antlia	Ant
3	Apus	Aps
4	Aquarius	Aqr
5	Aquila	Aql
6	Ara	Ara
7	Aries	Ari
8	Auriga	Aur
9	Boötes	Boo
10	Caelum	Cae
11	Camelopardalis	Cam
12	Cancer	Cnc
13	Canes Venatici	CVn
14	Canis Major	CMa
15	Canis Minor	CMi
16	Capricornus	Cap
17	Carina	Car
18	Cassiopeia	Cas
19	Centaurus	Cen
20	Cepheus	Cep
21	Cetus	Cet
22	Chamaeleon	Cha
23	Circinus	Cir
24	Columba	Col
25	Coma Berenices	Com
26	Corona Australis	CrA
27	Corona Borealis	CrB
28	Corvus	Crv
29	Crater	Crt
30	Crux	Cru
31	Cygnus	Cyg
32	Delphinus	Del
33	Dorado	Dor
34	Draco	Dra
35	Equuleus	Equ
36	Eridanus	Eri
37	Fornax	For
38	Gemini	Gem
39	Grus	Gru
40	Hercules	Her
41	Horologium	Hor
42	Hydra	Hya
43	Hydrus	Hyi
44	Indus	Ind

No.	Constellation	Abbreviation
45	Lacerta	Lac
46	Leo	Leo
47	Leo Minor	LMi
48	Lepus	Lep
49	Libra	Lib
50	Lupus	Lup
51	Lynx	Lyn
52	Lyra	Lyr
53	Mensa	Men
54	Microscopium	Mic
55	Monoceros	Mon
56	Musca	Mus
57	Norma	Nor
58	Octans	Oct
59	Ophiuchus	Oph
60	Orion	Ori
61	Pavo	Pav
62	Pegasus	Peg
63	Perseus	Per
64	Phoenix	Phe
65	Pictor	Pic
66	Pisces	Psc
67	Piscis Austrinus	PsA
68	Puppis	Pup
69	Pyxis	Pyx
70	Reticulum	Ret
71	Sagitta	Sge
72	Sagittarius	Sgr
73	Scorpius	Sco
74	Sculptor	Scl
75	Scutum	Sct
76	Serpens	Ser
77	Sextans	Sex
78	Taurus	Tau
79	Telescopium	Tel
80	Triangulum	Tri
81	Triangulum Australe	TrA
82	Tucana	Tuc
83	Ursa Major	UMa
84	Ursa Minor	UMi
85	Vela	Vel
86	Virgo	Vir
87	Volans	Vol
88	Vulpecula	Vul

## Double/Multi Stars

No.	HC Item		Constellation	Name	HIP	WDS	SAO
1	Rigel Kentaurus A	Alpha Centauri	Centaurus		71683	14396-6050	252838
2	Rigel	Beta Orionis	Orion		24436	05145-0812	131907
3	Gacrux	Gamma Crucis	Crux		61084	12312-5707	240019
4	Sargas	Theta Scorpii	Scorpius		86228	17373-4300	228201
5	Castor A	Alpha Geminorum	Gemini		36850	07346+3153	60198
6	Mizar	Zeta Ursae Majoris	Ursa Major		65378	13239+5456	28737
7	Almach	Gamma Andromedae	Andromeda		9640	02039+4220	37735
8	Algieba	Gamma Leonis	Leo		50583	10200+1950	81298
9	Aludra	Eta Canis Majoris	Canis Major		35904	07241-2918	173651
10	Iritjinga (Cen)	Gamma Centauri	Centaurus	Muhlifain	61932	12415-4858	223603
11	Zubenelgenubi	Alpha Librae	Libra		72603	14509-1603	158836
12	Alcyone	Eta Tauri	Taurus		17702	03475+2406	76199
13	Cor Caroli	Alpha Canum Venaticorum	Canes Venatici		63125	12560+3819	63257
14	Acamar	Theta Eridani	Eridanus		13847	02583-4018	216113
15	Adhafera	Zeta Leonis	Leo		50335	10167+2325	81265
16	Rasalgethi	Alpha Herculis	Hercules		84345	17146+1423	102680
17	Meissa	Lambda Orionis	Orion		26207	05351+0956	112921
18	Graffias	Beta1 Scorpii	Scorpius		78820	16054-1948	159682
19	Alya	Theta Serpentis	Serpens		92946	18562+0412	124068
20	HIP 48002	Upsilon Carinae	Carina	Vathorz Prior		09471-6504	250695
21	HIP 95947	Beta1 Cygni	Cygnus	Albireo		19307+2758	87301
22	HIP 20894	Theta2 Tauri	Taurus			04287+1552	93957
23	HIP 74395	Zeta Lupi	Lupus			15123-5206	242304
24	HIP 27072	Gamma Leporis	Lupus			05445-2227	170759
25	HIP 26549	Sigma Orionis	Orion			05387-0236	132406
26	HIP 85667	HD 158614	Ophiuchus			17304-0104	141702
27	HIP 74376	Kappa1 Lupi	Lupus			15119-4844	225525
28	HIP 34481	Gamma2 Volantis	Carina			07087-7030	256374
29	HIP 53253	u Carinae	Carina			10535-5851	238574
30	HIP 99675	Omicron1 Cygni	Cygnus	31 Cyg		20136+4644	49337
31	HIP 63003	Mu1 Crucis	Crux			12546-5711	240366
32	HIP 43103	Iota Cancri	Cancer	48 Cnc		08467+2846	80416
33	HIP 110991	Delta Cephei	Cepheus	27 Cep		22292+5825	34508
34	HIP 20635	Kappa1 Tauri	Taurus	65 Tau		04254+2218	76601
35	HIP 88601	70 Ophiuchi	Orion			18055+0230	123107
36	HIP 2484	Beta1 Tucanae	Horologium			00315-6257	248201
37	HIP 91971	Zeta1 Lyrae	Cygnus	6 Lyr		18448+3736	67321
38	HIP 79374	Nu Scorpii	Scorpius	Jabbah		16120-1928	159764
39	HIP 102532	Gamma2 Delphini	Pegasus	12 Del		20467+1607	106476
40	HIP 52154	x Velorum	Vela			10393-5536	238309
41	HIP 37229	HD 61555	Canis Major			07388-2648	174198
42	HIP 30419	Epsilon Monocerotis	Orion	8 Mon		06238+0436	113810
43	HIP 108917	Xi Cephei	Cepheus.	Al kurhah		22038+6438	19827
44	HIP 53417	54 Leonis	Leo			10556+2445	81584
45	HIP 65271	J Centauri	Centaurus			13226-6059	252284
46	HIP 67669	3 Centauri	Centaurus			13518-3300	204916
47	HIP 105319	Theta Indi	Indus			21199-5327	246965
48	HIP 80582	Epsilon Normae	Norma			16272-4733	226773
49	HIP 8832	Gamma Arietis	Aries			01535+1918	92680
50	HIP 69483	Kappa Boötis	Boötes	Asellus Tertius		14135+5147	29045
51	HIP 92946	Theta Serpentis	Serpens			18562+0412	124068
52	HIP 86614	Psi1 Draconis	Draco	31 Draconis		17419+7209	8890

No.	HC Item		Constellation	Name	HIP	WDS	SAO
53	HIP 95771	Alpha Vulpeculae	Vulpecula	Anser		19287+2440	87261
54	HIP 30867	Beta Monocerotis	Monoceros			06288-0702	133316
55	HIP 35363	NV Puppis	Puppis			07183-3644	197824
56	HIP 94761	Gliese 752	Aquila	Wolf 1055, Ross 652		19169+0510	
57	HIP 21683	Sigma2 Tauri	Taurus			04393+1555	94054
58	HIP 8497	Chi Ceti	Cetus	53 Cet		01496-1041	148036
59	HIP 26199	HD 36960	Orion			05350-0600	132301
60	HIP 104521	Gamma Equulei	Equuleus	5 Equ		21103+1008	126593
61	HIP 116389	Iota Phoenicis	Phoenix			23351-4237	231675
62	HIP 17797	HD 24071	Eridanus			03486-3737	194550
63	HIP 21036	83 Tauri	Taurus			04306+1343	93979
64	HIP 107310	Mu1 Cygni	Cygnus	78 Cyg		21441+2845	89940
65	HIP 72659	Xi Boötis	Boötes	37 Boo		14514+1906	101250
66	HIP 21029	HD 28527	Taurus			04306+1612	93975
67	HIP 42726	HY Velorum	Vela			08424-5307	236205
68	HIP 18255	32 Eridani	Eridanus			03543-0257	130806
69	HIP 9153	Lambda Arietis	Aries			01580+2336	75051
70	HIP 88267	95 Herculis	Hercules			18015+2136	85648
71	HIP 85829	Nu2 Draconis	Draco	25 Dra		17322+5511	30450
72	HIP 43937	V376 Carinae	Carina	b1 Carinae		08570-5914	236436
73	HIP 71762	Pi2 Boötis	Boötes	29 Boo		14407+1625	101139
74	HIP 80047	Delta1 Apodis	Apus			16203-7842	257380
75	HIP 58484	Epsilon Chamaeleontis	Chamaeleon			11596-7813	256894
76	HIP 25142	23 Orionis	Orion			05228+0333	112697
77	HIP 54204	Chi1 Hydrae	Hydra			11053-2718	179514
78	HIP 76669	Zeta Coronae Borealis	Corona Borealis	7 CrB		15394+3638	64833
79	HIP 99770	b3 Cygni	Cygnus	29 Cyg		20145+3648	69678
80	HIP 101027	Rho Capricorni	Capricornus	11 Cap		20289-1749	163614
81	HIP 74911	Nu Lupi	Lupus			15185-4753	225638
82	HIP 35210	HD 56577	Canis Major			07166-2319	173349
83	HIP 26235	Theta2 Orionis	Orion	43 Ori		05354-0525	132321
84	HIP 40321	OS Puppis	Puppis			08140-3619	198969
85	HIP 70327	HD 126129	Boötes			14234+0827	120426
86	HIP 26221	Theta1 Orionis	Orion	Trapezium		05353-0523	132314
87	HIP 80473	Rho Ophiuchi	Ophiuchus	5 Oph		16256-2327	184381
88	HIP 78105	Xi1 Lupi	Lupus			15569-3358	207144
89	HIP 79043	Kappa Herculis	Hercules	7 Her		16081+1703	101951
90	HIP 61418	24 Comae Berenices	Coma Berenices			12351+1823	100160
91	HIP 91919	Epsilon Lyrae	Lyra	4 Lyr		18443+3940	67309
92	HIP 41639	HD 72127	Vela			08295-4443	219996
93	HIP 104214	61 Cygni	Cygnus			21069+3845	70919
94	HIP 23734	11 Camelopardalis	Camelopardalis			05061+5858	25001
95	HIP 60189	Zeta Corvi	Corvus	5 Crv		12206-2213	180700
96	HIP 66821	Q Centauri	Centaurus			13417-5434	241076
97	HIP 14043	HD 18537	Perseus			03009+5221	23763
98	HIP 5737	Zeta Piscium	Pisces	86 Psc		01137+0735	109739
99	HIP 84626	Omicron Ophiuchi	Ophiuchus	39 Oph		17180-2417	185238
100	HIP 60904	17 Comae Berenices	Coma Berenices			12289+2555	82330
101	HIP 58684	67 Ursae Majoris	Ursa Major			12021+4303	44002
102	HIP 5131	Psi1 Piscium	Pisces	74 Psc		01057+2128	74482
103	HIP 115126	94 Aquarii	Aquarius			23191-1328	165625
104	HIP 62572	HD 112028	Camelopardalis			12492+8325	2102

No.	HC Item		Constellation	Name	HIP	WDS	SAO
105	HIP 40167	Zeta1 Cancr	Cancer	Tegmen		08122+1739	97645
106	HIP 40817	Kappa Volantis	Volans			08198-7131	256497
107	HIP 81292	17 Draconis	Draco			16362+5255	30013
108	HIP 80197	Nu1 Coronae Borealis	Corona Borealis			16224+3348	65257
109	HIP 88060	HD 163756	Sagittarius			17591-3015	209553
110	HIP 42637	Eta Chamaeleontis	Chamaeleon			08413-7858	256543
111	HIP 21039	81 Tauri	Taurus			04306+1542	93978
112	HIP 100965	75 Draconis	Draco			20282+8125	3408
113	HIP 25768	HD 36553	Pictor			05302-4705	217368
114	HIP 93717	15 Aquilae	Aquila			19050-0402	142996
115	HIP 79980	HD 148836	Scorpius			16195-3054	207558
116	HIP 12086	15 Trianguli	Triangulum			02358+3441	55687
117	HIP 90968	Kappa2 Coronae Austr	Corona Australis			18334-3844	210295
118	HIP 22531	Iota Pictoris	Pictor			04509-5328	233709
119	HIP 34065	HD 53705	Puppis			07040-4337	218421
120	HIP 79607	Sigma Coronae Boreali	Corona Borealis			16147+3352	65165
121	HIP 109786	41 Aquarii	Aquarius			22143-2104	190986
122	HIP 56280	17 Crateris	Hydra			11323-2916	179968
123	HIP 51561	HD 91355	Vela			10320-4504	222126
124	HIP 107930	HD 208095	Cepheus			21520+5548	33819
125	HIP 97966	57 Aquilae	Aquila			19546-0814	143898
126	HIP 117218	107 Aquarii	Aquarius.			23460-1841	165867
127	HIP 82676	HD 152234	Scorpius			16540-4148	227377
128	HIP 111546	8 Lacertae	Lacerta			22359+3938	72509
129	HIP 29151	HD 42111	Orion			06090+0230	113507
130	HIP 107253	79 Cygni	Cygnus			21434+3817	71643
131	HIP 88136	41 Draconis	Draco			18002+8000	8996
132	HIP 81702	HD 150136	Ara			16413-4846	227049
133	HIP 97423	HD 186984	Sagittarius			19480-1342	162998
134	HIP 30444	HD 45145	Columba			06240-3642	196774
135	HIP 66400	HD 118349	Hydra			13368-2630	181790
136	HIP 17579	21 Tauri	Taurus	Asterope		03459+2433	76159
137	HIP 35785	19 Lyncis	Lynx			07229+5517	26312
138	HIP 81641	37 Herculis	Hercules			16406+0413	121776
139	HIP 7751	p Eridani	Eridanus			01398-5612	232490
140	HIP 21148	1 Camelopardalis	Camelopardalis			04320+5355	24672
141	HIP 9021	56 Andromedae	Andromeda			01562+3715	55107
142	HIP 97816	HD 187420	Telescopium			19526-5458	246311
143	HIP 88818	100 Herculis	Hercules			18078+2606	85753
144	HIP 36817	HD 60584	Puppis			07343-2328	174019
145	HIP 25695	HD 35943	Taurus			05293+2509	77200
146	HIP 98819	15 Sagittae	Sagitta			20041+1704	105635
147	HIP 61910	VV Corvi	Corvus			12413-1301	157447
148	HIP 111643	Sigma2 Gruis	Grus			22370-4035	231217
149	HIP 80399	HD 147722	Scorpius			16247-2942	184368
150	HIP 83478	HD 154228	Hercules			17037+1336	102564
151	HIP 101123	Omicron Capricorni	Capricornus			20299-1835	163626
152	HIP 28271	59 Orionis	Orion			05584+0150	113315
153	HIP 64246	17 Canum Venaticoru	Canes Venatici			13101+3830	63380
154	HIP 96895	16 Cygni	Cygnus			19418+5032	31898
155	HIP 35564	HD 57852	Carina			07204-5219	235110
156	HIP 37843	2 Puppis	Puppis			07455-1441	153363

No.	HC Item		Constellation	Name	HIP	WDS	SAO
157	HIP 28790	HD 41742	Puppis			06047-4505	217706
158	HIP 4675	HD 5788	Andromeda			01001+4443	36832
159	HIP 31676	8 Lyncis	Lynx			06377+6129	13897
160	HIP 10176	59 Andromedae	Andromeda			02109+3902	55330
161	HIP 25950	HD 36408	Taurus			05322+1703	94630
162	HIP 117931	AL Sculptoris	Sculptor			23553-3155	214860
163	HIP 81914	HD 150591	Scorpius			16439-4107	227123
164	HIP 21242	m Persei	Perseus			04334+4304	39604
165	HIP 86831	61 Ophiuchi	Ophiuchus			17446+0235	122690
166	HIP 115272	HD 220003	Grus			23208-5018	247838
167	HIP 46657	Zeta1 Antliae	Antlia			09308-3153	200444
168	HIP 41404	Phi2 Cancri	Cancer			08268+2656	80188
169	HIP 29388	41 Aurigae	Auriga			06116+4843	40925
170	HIP 49321	HD 87344	Hydra			10040-1806	155704
171	HIP 84054	63 Herculis	Hercules			17111+2414	84896
172	HIP 39035	HD 66005	Puppis			07592-4959	219249
173	HIP 25303	Theta Pictoris	Pictor			05248-5219	233965
174	HIP 52520	HD 93344	Carina			10443-7052	256750
175	HIP 95398	2 Sagittae	Sagitta			19244+1656	104797
176	UCAC4 277-135548						
177	HIP 32609	HD 48766	Lynx			06482+5542	25963
178	HIP 101765	48 Cygni	Cygnus			20375+3134	70287
179	HIP 24825	YZ Leporis	Lepus			05193-1831	150335
180	HIP 31158	21 Geminorum	Gemini			06323+1747	95795
181	HIP 3885	65 Piscium	Pisces			00499+2743	74295
182	HIP 93371	HD 176270	Australis			19011-3704	210816
183	HIP 36345	HD 59499	Puppis			07289-3151	198038
184	HIP 108364	HD 208947	Cepheus			21572+6609	19760
185	HIP 50939	HD 90125	Sextans			10242+0222	118278
186	HIP 76603	HD 139461	Libra			15387-0847	140672
187	HIP 32269	HD 49219	Carina			06442-5442	234683
188	HIP 42516	39 Cancri	Cancer			08401+2000	80333
189	HIP 62807	32 Comae Berenices	Coma Berenices			12522+1704	100309
190	UCAC4 226-128246						
191	HIP 94913	24 Aquilae	Aquila			19188+0020	124492
192	HIP 94336	HD 179958	Cygnus			19121+4951	48193
193	HIP 107299	HD 206429	Indus			21440-5720	247151
194	HIP 59984	HD 106976	Virgo			12182-0357	138704
195	HIP 16411	HD 21743	Taurus			03313+2734	75970
196	HIP 23287	HD 32040	Orion			05006+0337	112305
197	HIP 105637	HD 203857	Cygnus			21238+3721	71280
198	HIP 108925	HD 209744	Cepheus			22039+5949	34016
199	HIP 103814	HD 200011	Microscopium			21022-4300	230492
200	HIP 58112	65 Ursae Majoris	Ursa Major			11551+4629	43945
201	HIP 109354	V402 Lacertae	Lacerta			22093+4451	51698
202	HIP 43822	17 Hydrae	Hydra			08555-0758	136409
203	HIP 21986	55 Eridani	Eridanus			04436-0848	131442
204	HIP 17470	HD 23245	Taurus			03446+2754	76122
205	HIP 35960	V368 Puppis	Puppis			07248-3717	197974
206	HIP 42936	HD75086	Carina			08451-5843	236241
207	HIP 19272	SZ Camelopardalis	Camelopardalis			04078+6220	13031
208	HIP 76143	HD 138488	Libra			15332-2429	183565



## IOPTRON TWO YEAR TELESCOPE, MOUNT, AND CONTROLLER WARRANTY

A. iOptron warrants your telescope, mount, or controller to be free from defects in materials and workmanship for two years. iOptron will repair or replace such product or part which, upon inspection by iOptron, is found to be defective in materials or workmanship. As a condition to the obligation of iOptron to repair or replace such product, the product must be returned to iOptron together with proof-of-purchase satisfactory to iOptron.

B. The Proper Return Merchant Authorization Number must be obtained from iOptron in advance of return. Call iOptron at 1.781.569.0200 to receive the RMA number to be displayed on the outside of your shipping container. All returns must be accompanied by a written statement stating the name, address, and daytime telephone number of the owner, together with a brief description of any claimed defects. Parts or product for which replacement is made shall become the property of iOptron.

The customer shall be responsible for all costs of transportation and insurance, both to and from the factory of iOptron, and shall be required to pre-pay such costs.

iOptron shall use reasonable efforts to repair or replace any telescope, mount, or controller covered by this warranty within thirty days of receipt. In the event repair or replacement shall require more than thirty days, iOptron shall notify the customer accordingly. iOptron reserves the right to replace any product which has been discontinued from its product line with a new product of comparable value and function.

This warranty shall be void and of no force of effect in the event a covered product has been modified in design or function, or subjected to abuse, misuse, mishandling or unauthorized repair. Further, product malfunction or deterioration due to normal wear is not covered by this warranty.

IOPTRON DISCLAIMS ANY WARRANTIES, EXPRESS OR IMPLIED, WHETHER OF MERCHANTABILITY OF FITNESS FOR A PARTICULAR USE, EXCEPT AS EXPRESSLY SET FORTH HERE. THE SOLE OBLIGATION OF IOPTRON UNDER THIS LIMITED WARRANTY SHALL BE TO REPAIR OR REPLACE THE COVERED PRODUCT, IN ACCORDANCE WITH THE TERMS SET FORTH HERE. IOPTRON EXPRESSLY DISCLAIMS ANY LOST PROFITS, GENERAL, SPECIAL, INDIRECT OR CONSEQUENTIAL DAMAGES WHICH MAY RESULT FROM BREACH OF ANY WARRANTY, OR ARISING OUT OF THE USE OR INABILITY TO USE ANY IOPTRON PRODUCT. ANY WARRANTIES WHICH ARE IMPLIED AND WHICH CANNOT BE DISCLAIMED SHALL BE LIMITED IN DURATION TO A TERM OF TWO YEARS FROM THE DATE OF ORIGINAL RETAIL PURCHASE.

Some states do not allow the exclusion or limitation of incidental or consequential damages or limitation on how long an implied warranty lasts, so the above limitations and exclusions may not apply to you.

This warranty gives you specific legal rights, and you may also have other rights which vary from state to state.

iOptron reserves the right to modify or discontinue, without prior notice to you, any model or style telescope.

If warranty problems arise, or if you need assistance in using your telescope, mount, or controller contact:

iOptron Corporation  
Customer Service Department  
6E Gill Street  
Woburn, MA01801  
[www.ioptron.com](http://www.ioptron.com)  
support@ioptron.com  
Tel. (781)569-0200  
Fax. (781)935-2860  
Monday-Friday 9AM-5PM EST

NOTE: This warranty is valid to U.S.A. and Canadian customers who have purchased this product from an authorized iOptron dealer in the U.S.A. or Canada or directly from iOptron. Warranty outside the U.S.A. and Canada is valid only to customers who purchased from an iOptron Distributor or Authorized iOptron Dealer in the specific country. Please contact them for any warranty.