

**EVIDENT**

Biological Microscope

**CX43/CX33**

CX3 Series

Comfortable, High-Throughput Routine Microscopy

**UIS2**  
World-leading optics



## Comfortable for Long Periods of Routine Microscopy

The microscope frame fits comfortably between your hands, and the location of the control knobs help maximize the ergonomics, improving work efficiency. Users can quickly set a specimen with one hand, while adjusting the focus and operating the stage with the other with minimal movement. Both microscopes also feature a camera port for digital imaging.

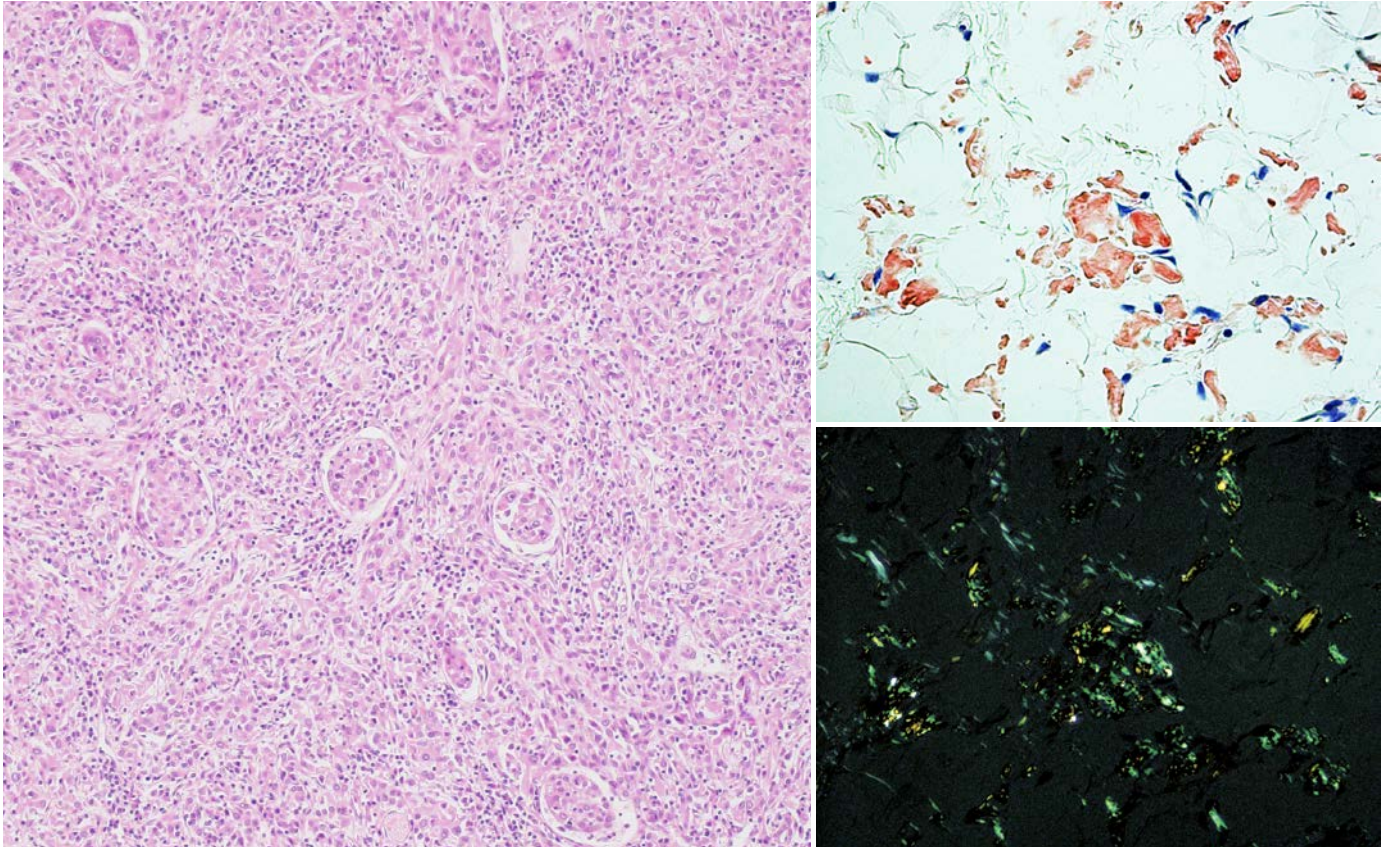

CX43

# Maintain Preferred Observation Conditions with Minimal Adjustments

## Uniform Illumination with Consistent Color Temperature

The color temperature of the CX LED illumination produces daylight conditions, so specimens can be viewed with their natural colors. The color temperature is consistent at any brightness, so users don't have to spend time making adjustments when they change brightness. The LEDs have a long 60,000-hour lifetime, helping reduce cost, and the brightness level remains stable throughout the LED's life.



## Excellent Optical Performance for Flat Images

The microscope employs Plan Achromat objectives, which provide clear images with high image flatness over a wide field of view. This helps users view specimens clearly and evenly during routine microscope observations.

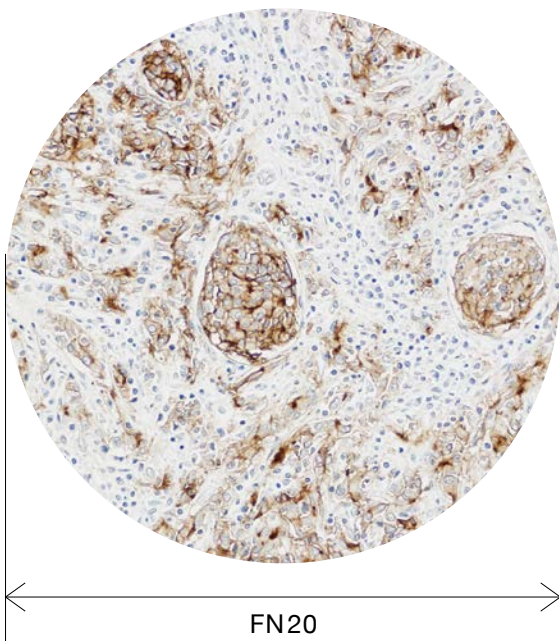

## Select and Set Your Contrast Level

Users can preserve their favorite contrast by locking the aperture diaphragm. It stays fixed at the optimally chosen position if it is accidentally touched while changing slides.



## Change Magnification without Adjusting the Condenser

Users can change the magnification from 4X to 100X without moving the top lens on the condenser. 2X magnification is also available by simply setting the objective and the condenser turret to the 2X position.



## Simple Fluorescence Observation

Fluorescence observation is simple and easy. Plug the compact fluorescent illuminator into the microscope frame for fluorescence observation. Its LED light source is pre-centered, and the transmitted illumination is shuttered by simply setting the condenser turret to the FL position. This reduces background noise in the fluorescence image from incidental light coming from the top lens of the condenser.



## Remain Comfortable During Extended Usage

### Single-Handed Sample Placement

A specimen can be quickly slid in and out using one hand. The specimen holder opens a little and firmly retains the specimen during operation. The versatile holder accommodates a variety of slide types, including a hemocytometer.



### Use Up to Five Objectives

For added flexibility, up to five objectives can be mounted on the revolving nosepiece. In addition to general objectives, users can select a 2X objective for wide area observation or objectives for phase contrast. These objectives with long working distances help keep specimens from getting damaged.



### Ergonomically-Positioned Focus Knob

The low-positioned focusing knob enables users to make observations while keeping their hands and forearms resting on the desk, helping provide comfort. The focusing stopper prevents a specimen from accidentally hitting an objective when working under high magnification.



### Smooth Magnification Change

The low-positioned revolving nosepiece enables users to quickly change magnifications with minimal arm movement between focusing, greatly improving work efficiency during prolonged use.



### Ergonomic Stage and Eyepiece Position

The low-positioned stage is designed to enhance comfort and reduce fatigue. The stage surface can be widely seen from the eye point position, which enables users to smoothly set and check specimens on the stage. The stage knob can be controlled with just a light touch and can be adjusted at the same time as the focusing knob, since they are located close together.



### Specimen Holders that Match Your Observation Style

Stage accessories improve efficiency when users need to observe a large number of specimens. With the specimen holder sheet, a specimen can be freely operated by a finger on the sheet and can be precisely adjusted using the stage knob. The double specimen holder can retain a large specimen or two specimens.

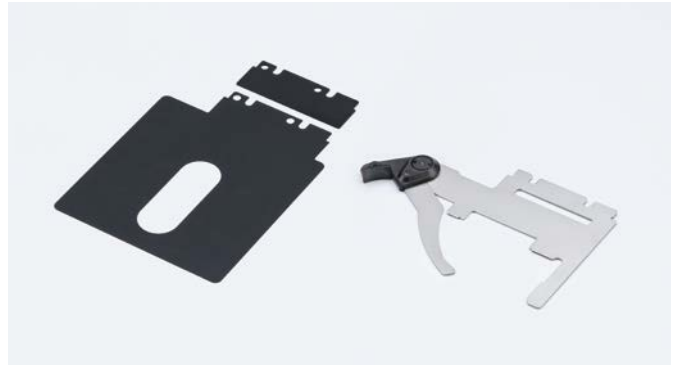

### Simplified Fluorescence Observation

Fluorescence observation can be easily set up on the standard configuration while keeping the eye point the same as other observation methods. Simply plug the compact fluorescent illuminator into the back of the microscope frame.



# Versatile Applications

The universal condenser offers a variety of observation methods and future upgradability. In combination with the five-position revolving nosepiece, multiple applications can be covered using the single microscope frame.

## Brightfield

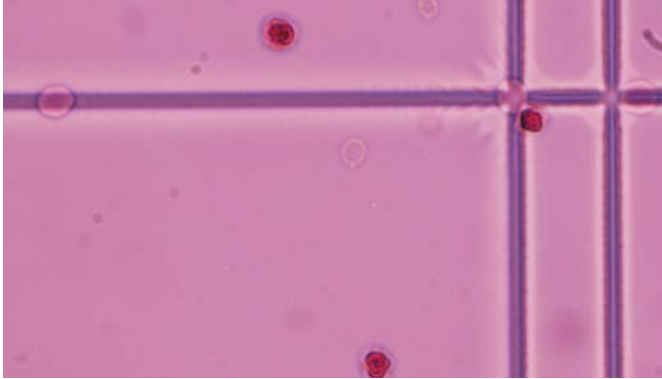

Leukocyte (minimum iris aperture)

## Brightfield

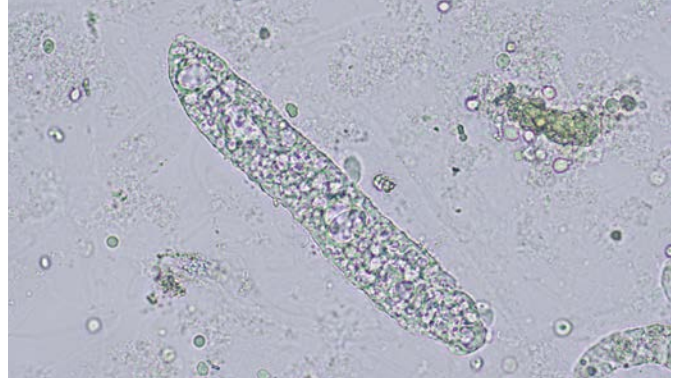

Urinary Cast (minimum iris aperture)

## Phase Contrast

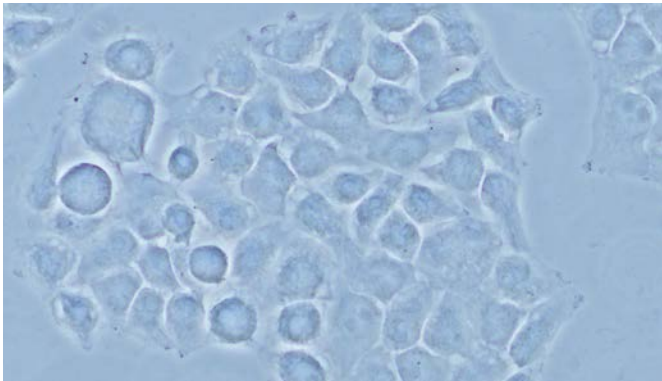

HeLa cells

## Fluorescence

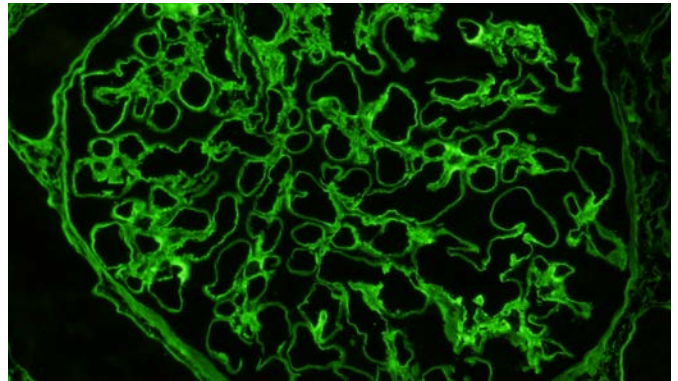

Renal Glomerulus

## Accessories

### Simple polarizing intermediate attachment/CX3-KPA

Offers polarized observation of urate crystals and amyloid in combination with a polarizer and analyzer.



### Eyepoint adjuster/ U-EPA2

Raise the eyepoint position by 30 mm (1.2 in.) for added comfort.



### Arrow pointer/ U-APT

Insert an LED arrow into your image; great for digital imaging and presentations.



### Dual observation attachment/U-DO3

Enables dual, simultaneous observation of a single specimen from the same direction with equal magnification and brightness for both operators. A pointer can be used to indicate specific sections of the specimen to simplify the training process and enhance discussion.



## CX33 Microscope

For less demanding requirements using only brightfield and darkfield, the CX33 microscope is a great option. The low-positioned nosepiece and stage, focusing lock, specimen holder, and inward quadruple revolving nosepiece make the it is well-suited for everyday observations in one easy configuration.



CX33

## CX43 System

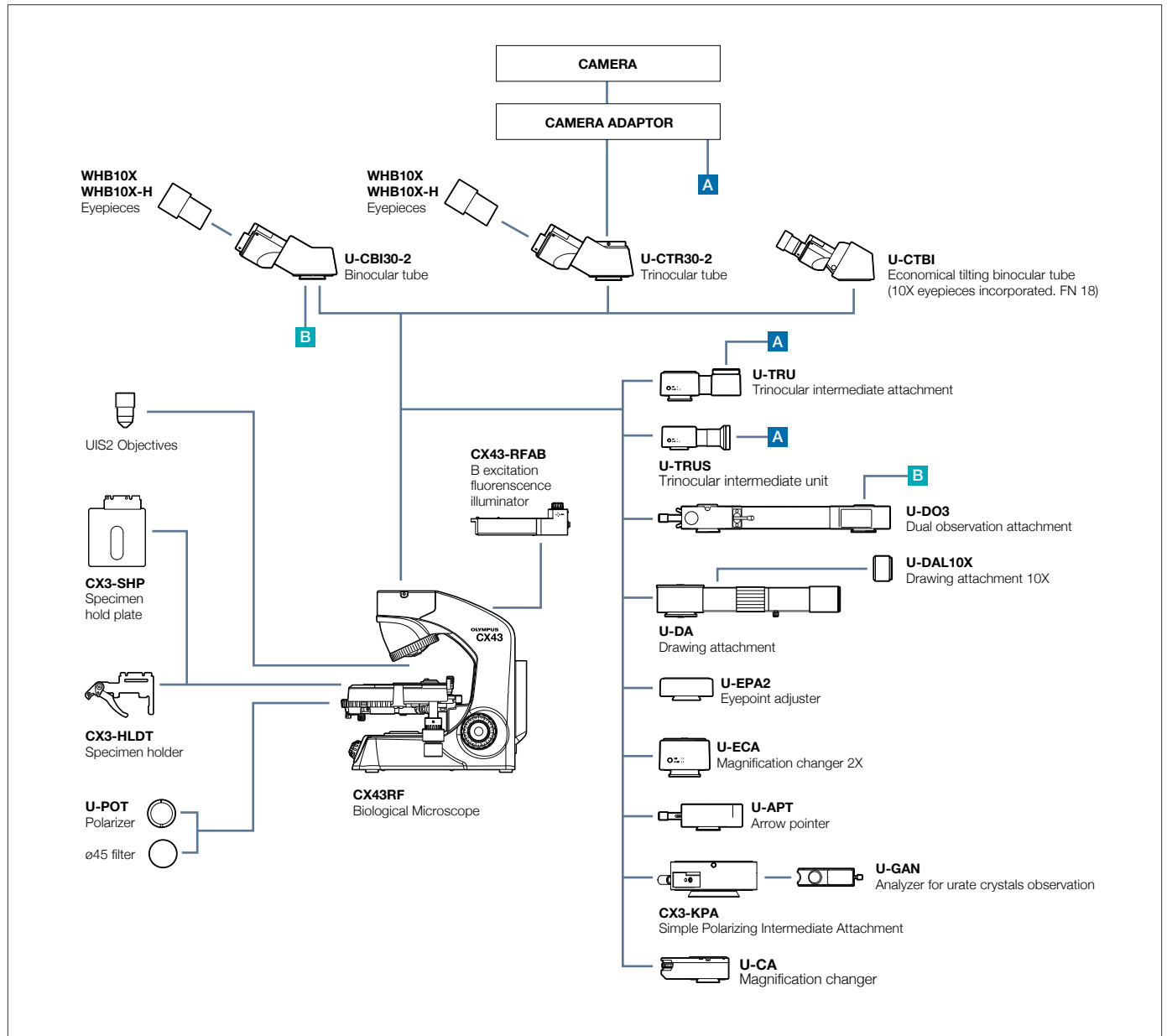

## Dimensions

(Unit: mm)

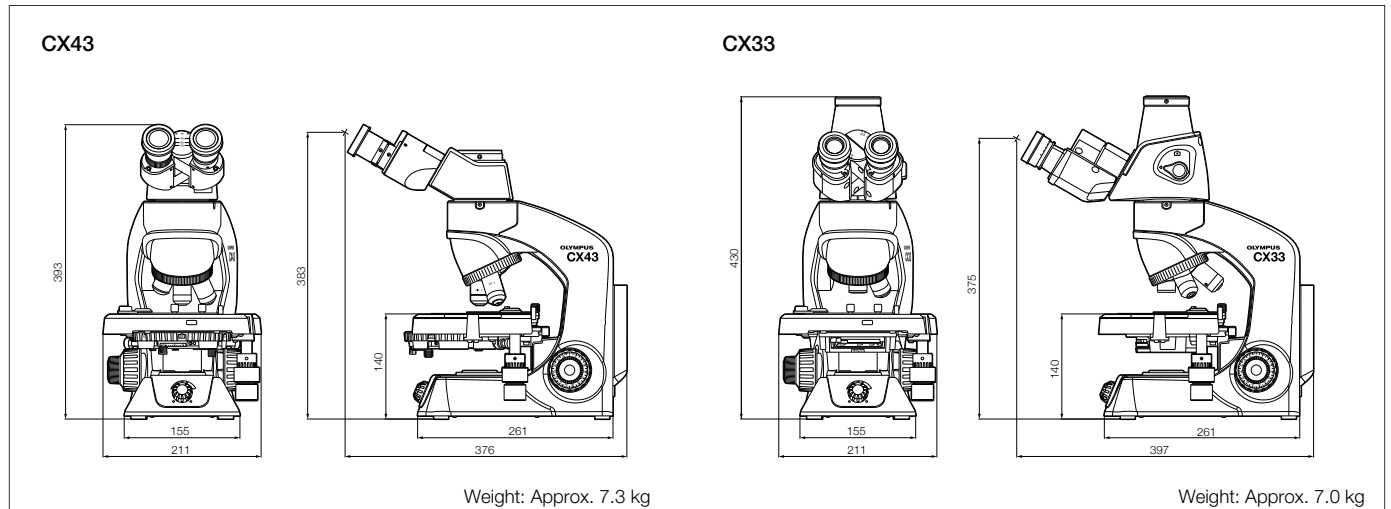

## CX43 Specifications

Optical System	UIS2 (universal infinity-corrected) optical system																																																																				
Illumination System	<ul style="list-style-type: none"> <li>Built-in transmitted illumination system</li> <li>Köhler illumination (fixed field diaphragm)</li> <li>LED power consumption 2.4 W (nominal value), precentered</li> </ul>																																																																				
Focusing	<ul style="list-style-type: none"> <li>Stage height movement (coarse movement stroke: 15 mm)</li> <li>Stroke per rotation for coarse adjustment knob: 36.8 mm, Focusing stopper</li> <li>Torque adjustment for coarse adjustment knob</li> <li>Fine focus knob (minimum adjustment gradations: 2.5 μm)</li> </ul>																																																																				
Revolving Nosepiece	Fixed quintuple nosepiece with inward tilt																																																																				
Stage	<ul style="list-style-type: none"> <li>Wire movement mechanical fixed stage, (W × D): 211 mm × 154 mm</li> <li>Traveling range (X × Y): 76 mm × 52 mm</li> <li>Single specimen holder (optional: double specimen holder, sheet holder)</li> <li>Specimen position scale</li> <li>Stage XY movement stopper</li> </ul>																																																																				
Observation Tube	Type	Binocular		Trinocular		Tilting binocular																																																															
	Eyepiece	10X Field Number (FN): 20		10X Field Number (FN): 20		10X Field Number (FN): 18																																																															
	Tube Inclination	30°		30°		30°–60°																																																															
	Light Path Selector	None		None (eyepiece/camera port = 50/50 fixed)		None																																																															
	Interpupillary Distance Adjusting Range	48–75 mm																																																																			
Condenser	<ul style="list-style-type: none"> <li>Abbe condenser NA 1.25 with oil immersion</li> <li>Universal condenser with 7 turret positions: BF (4–100X), 2X, DF, Ph1, Ph2, Ph3, FL</li> <li>Condenser turret lock pin (BF only)</li> <li>Built-in aperture iris diaphragm</li> <li>AS lock pin</li> </ul>																																																																				
Observation Methods	Brightfield, simple polarization, fluorescence, phase contrast, darkfield																																																																				
Objectives	<table border="0"> <tr> <td colspan="7">Plan achromat (UIS2)</td> </tr> <tr> <td>2X</td> <td>NA 0.06</td> <td>W.D. 5.8 mm</td> <td></td> <td></td> <td></td> <td></td> </tr> <tr> <td>4X</td> <td>NA 0.1</td> <td>W.D. 18.5 mm</td> <td></td> <td></td> <td></td> <td></td> </tr> <tr> <td>10X</td> <td>NA 0.25</td> <td>W.D. 10.6 mm</td> <td>10XPH</td> <td>NA 0.25</td> <td>W.D. 10.6 mm</td> <td></td> </tr> <tr> <td>20X</td> <td>NA 0.4</td> <td>W.D. 1.2 mm</td> <td>20XPH</td> <td>NA 0.4</td> <td>W.D. 1.2 mm</td> <td></td> </tr> <tr> <td>40X</td> <td>NA 0.65</td> <td>W.D. 0.6 mm</td> <td>40XPH</td> <td>NA 0.65</td> <td>W.D. 0.6 mm</td> <td></td> </tr> <tr> <td>60X</td> <td>NA 0.8</td> <td>W.D. 0.2 mm</td> <td></td> <td></td> <td></td> <td></td> </tr> <tr> <td>100XO</td> <td>NA 1.25</td> <td>W.D. 0.13 mm</td> <td>100XOPH</td> <td>NA 1.25</td> <td>W.D. 0.15 mm</td> <td></td> </tr> <tr> <td>100XOI</td> <td>NA 1.25–0.6</td> <td>W.D. 0.13 mm</td> <td></td> <td></td> <td></td> <td></td> </tr> </table>						Plan achromat (UIS2)							2X	NA 0.06	W.D. 5.8 mm					4X	NA 0.1	W.D. 18.5 mm					10X	NA 0.25	W.D. 10.6 mm	10XPH	NA 0.25	W.D. 10.6 mm		20X	NA 0.4	W.D. 1.2 mm	20XPH	NA 0.4	W.D. 1.2 mm		40X	NA 0.65	W.D. 0.6 mm	40XPH	NA 0.65	W.D. 0.6 mm		60X	NA 0.8	W.D. 0.2 mm					100XO	NA 1.25	W.D. 0.13 mm	100XOPH	NA 1.25	W.D. 0.15 mm		100XOI	NA 1.25–0.6	W.D. 0.13 mm				
Plan achromat (UIS2)																																																																					
2X	NA 0.06	W.D. 5.8 mm																																																																			
4X	NA 0.1	W.D. 18.5 mm																																																																			
10X	NA 0.25	W.D. 10.6 mm	10XPH	NA 0.25	W.D. 10.6 mm																																																																
20X	NA 0.4	W.D. 1.2 mm	20XPH	NA 0.4	W.D. 1.2 mm																																																																
40X	NA 0.65	W.D. 0.6 mm	40XPH	NA 0.65	W.D. 0.6 mm																																																																
60X	NA 0.8	W.D. 0.2 mm																																																																			
100XO	NA 1.25	W.D. 0.13 mm	100XOPH	NA 1.25	W.D. 0.15 mm																																																																
100XOI	NA 1.25–0.6	W.D. 0.13 mm																																																																			
Fluorescence Light Source	Easily add an LED reflected fluorescence illuminator (peak excitation wavelength 470 nm: B excitation only), precentered																																																																				
Rated Voltage/Electric Current	AC 100–240 V 50/60 Hz 0.4 A																																																																				

## CX33 Specifications

Optical System	Infinity optical system																																															
Illumination System	<ul style="list-style-type: none"> <li>Built-in transmitted illumination system</li> <li>Köhler illumination (fixed field diaphragm)</li> <li>LED power consumption 2.4 W (nominal value), precentered</li> </ul>																																															
Focusing	<ul style="list-style-type: none"> <li>Stage height movement (coarse movement stroke: 15 mm)</li> <li>Stroke per rotation for coarse adjustment knob: 36.8 mm, Focusing stopper</li> <li>Torque adjustment for coarse adjustment knob</li> <li>Fine focus knob (minimum adjustment gradations: 2.5 μm)</li> </ul>																																															
Revolving Nosepiece	Fixed quadruple nosepiece with inward tilt																																															
Stage	<ul style="list-style-type: none"> <li>Wire movement mechanical fixed stage, (W × D): 211 mm × 154 mm</li> <li>Traveling range (X × Y): 76 mm × 52 mm</li> <li>Single specimen holder (optional: double specimen holder, sheet holder)</li> <li>Specimen position scale</li> <li>Stage XY movement stopper</li> </ul>																																															
Observation Tube	<ul style="list-style-type: none"> <li>30° inclined trinocular tube</li> <li>Light path selector: eyepiece/camera port = 100/0 or 0/100</li> <li>Interpupillary distance adjusting range: 48–75 mm</li> <li>Eyepoint adjustment: 375.0–427.9 mm</li> </ul>																																															
Eyepieces	<ul style="list-style-type: none"> <li>10X Field Number (FN): 20</li> <li>15X Field Number (FN): 16 (optional)</li> </ul>																																															
Condenser	<ul style="list-style-type: none"> <li>Abbe condenser NA 1.25 with oil immersion</li> <li>Built-in aperture iris diaphragm</li> </ul>																																															
Observation Methods	Brightfield, darkfield																																															
Objectives	<table border="0"> <tr> <td colspan="7">Plan achromat</td> </tr> <tr> <td>4X</td> <td>NA 0.1</td> <td>W.D. 27.8 mm</td> <td></td> <td></td> <td></td> <td></td> </tr> <tr> <td>10X</td> <td>NA 0.25</td> <td>W.D. 8.0 mm</td> <td></td> <td></td> <td></td> <td></td> </tr> <tr> <td>20X</td> <td>NA 0.4</td> <td>W.D. 2.5 mm (optional)</td> <td></td> <td></td> <td></td> <td></td> </tr> <tr> <td>40X</td> <td>NA 0.65</td> <td>W.D. 0.6 mm</td> <td></td> <td></td> <td></td> <td></td> </tr> <tr> <td>100X</td> <td>NA 1.25</td> <td>W.D. 0.13 mm (optional)</td> <td></td> <td></td> <td></td> <td></td> </tr> </table>						Plan achromat							4X	NA 0.1	W.D. 27.8 mm					10X	NA 0.25	W.D. 8.0 mm					20X	NA 0.4	W.D. 2.5 mm (optional)					40X	NA 0.65	W.D. 0.6 mm					100X	NA 1.25	W.D. 0.13 mm (optional)				
Plan achromat																																																
4X	NA 0.1	W.D. 27.8 mm																																														
10X	NA 0.25	W.D. 8.0 mm																																														
20X	NA 0.4	W.D. 2.5 mm (optional)																																														
40X	NA 0.65	W.D. 0.6 mm																																														
100X	NA 1.25	W.D. 0.13 mm (optional)																																														
Rated Voltage/Electric Current	AC 100–240 V 50/60 Hz 0.4 A																																															

- EVIDENT CORPORATION is ISO14001 certified.
- EVIDENT CORPORATION is ISO9001 certified.
- EVIDENT CORPORATION is ISO13485 certified.

- All company and product names are registered trademarks and/or trademarks of their respective owners.
- Specifications and appearances are subject to change without any notice or obligation on the part of the manufacturer.

EvidentScientific.com

**EVIDENT**

EVIDENT CORPORATION  
Shinjuku Monolith, 2-3-1 Nishi-Shinjuku, Shinjuku-ku, Tokyo 163-0910, Japan

**OLYMPUS**