

INSTRUCTION MANUAL

Orion SpaceProbe™ 130mm EQ

#9851 Equatorial Newtonian Reflector Telescope



 **ORION**
TELESCOPES & BINOCULARS
Providing Exceptional Consumer Optical Products Since 1975

Customer Support (800) 676-1343
E-mail: support@telescope.com
Corporate Offices (831) 763-7000
89 Hangar Way, Watsonville, CA 95076

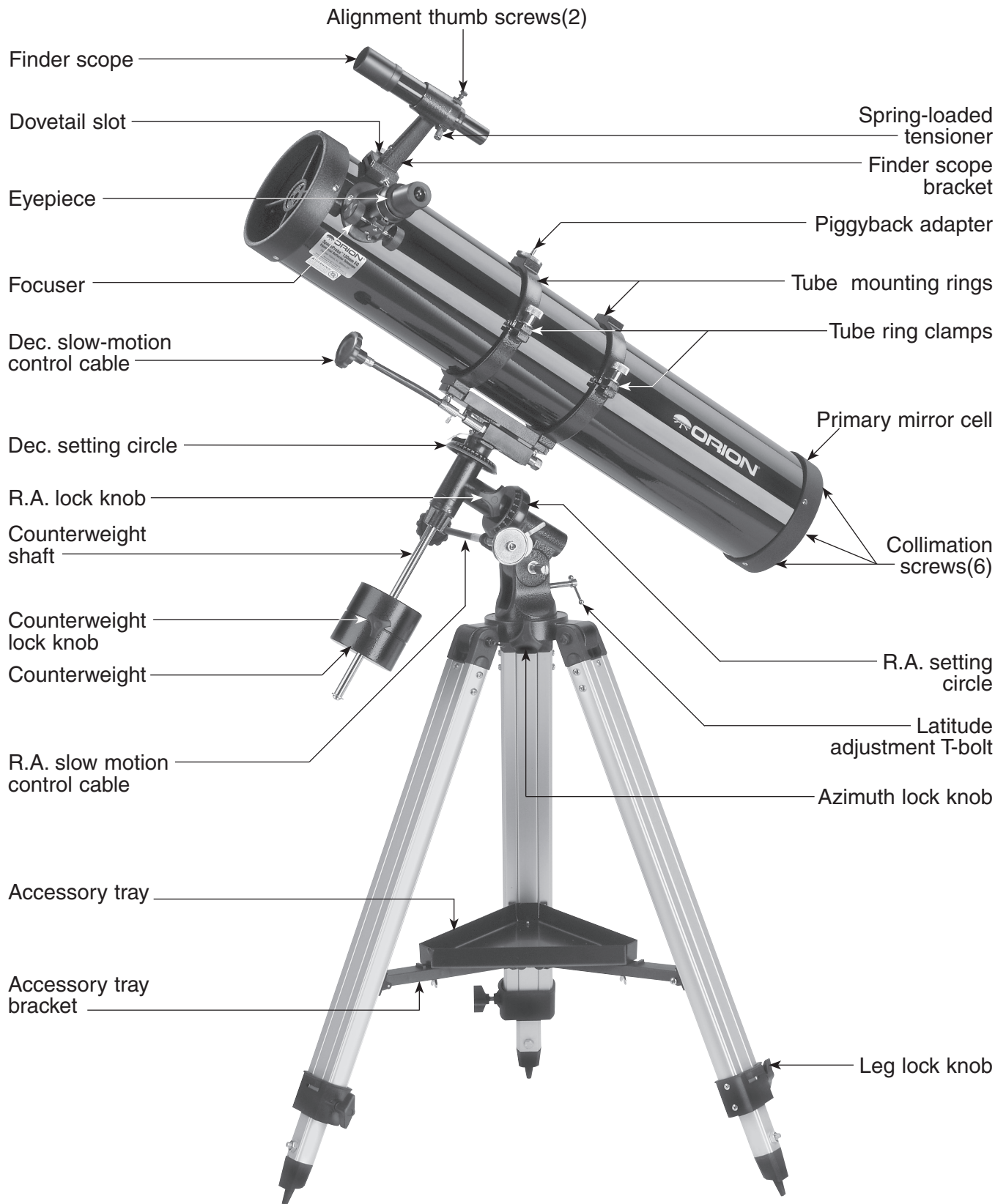

Figure 1. The SpaceProbe 130 EQ parts diagram

Congratulations on your purchase of a quality Orion telescope. Your new SpaceProbe 130mm EQ is designed for high-resolution viewing of astronomical objects. With its precision optics and equatorial mount, you'll be able to locate and enjoy hundreds of fascinating celestial denizens, including the planets, Moon, and a variety of deep-sky galaxies, nebulae, and star clusters.

If you have never owned a telescope before, we would like to welcome you to amateur astronomy. Take some time to familiarize yourself with the night sky. Learn to recognize the patterns of stars in the major constellations. With a little practice, a little patience, and a reasonably dark sky away from city lights, you'll find your telescope to be a never-ending source of wonder, exploration, and relaxation.

These instructions will help you set up, properly use and care for your telescope. Please read them over thoroughly before getting started.

Table of Contents

1. Unpacking	3
2. Parts List	3
3. Assembly	3
4. Getting Started	6
5. Setting Up and Using the Equatorial Mount	8
6. Collimating the Optics	10
7. Using Your Telescope— Astronomical Observing	12
8. Care and Maintenance	15
9. Specifications	16

1. Unpacking

The entire telescope system will arrive in one box. Be careful unpacking the box. We recommend keeping the original shipping containers. In the event that the telescope needs to be shipped to another location, or returned to Orion for warranty repair, having the proper shipping containers will help ensure that your telescope will survive the journey intact.

Make sure all the parts in the Parts List are present. Be sure to check boxes carefully, as some parts are small. If anything

WARNING: *Never look directly at the Sun through your telescope or its finder scope—even for an instant—without a professionally made solar filter that completely covers the front of the instrument, or permanent eye damage could result. Be sure to also cover the front of the finder scope with aluminum foil or another opaque material to prevent physical damage to the internal components of the scope itself as well as to your eye. Young children should use this telescope only with adult supervision.*

appears to be missing or broken, immediately call Orion Customer Support (800-676-1343) for assistance.

2. Parts List

Qty.	Description
1	Optical Tube Assembly
1	Optical tube dust cap
2	Optical tube mounting rings
1	25mm (36x) Explorer II eyepiece (1.25")
1	10mm (90x) Explorer II eyepiece (1.25")
1	6x30 crosshair finder scope
1	Dovetail finder scope bracket with O-ring
1	Equatorial mount
3	Tripod legs with attached accessory tray bracket
1	Counterweight shaft
1	Counterweight
1	Tripod accessory tray
3	Accessory tray wing screws (may be attached to accessory tray)
2	Slow-motion control cables
4	Assembly tools (2 wrenches, Phillips head screwdriver, flat head screwdriver key)
1	Collimation cap

3. Assembly

Assembling the telescope for the first time should take about 30 minutes. No tools are needed other than the ones provided. All screws should be tightened securely to eliminate flexing and wobbling, but be careful not to over-tighten or the threads may strip. Refer to Figure 1 during the assembly process.

During assembly (and anytime, for that matter), Do not touch the surfaces of the telescope mirrors or the lenses of the finder scopes or eyepieces with your fingers. The optical sur-

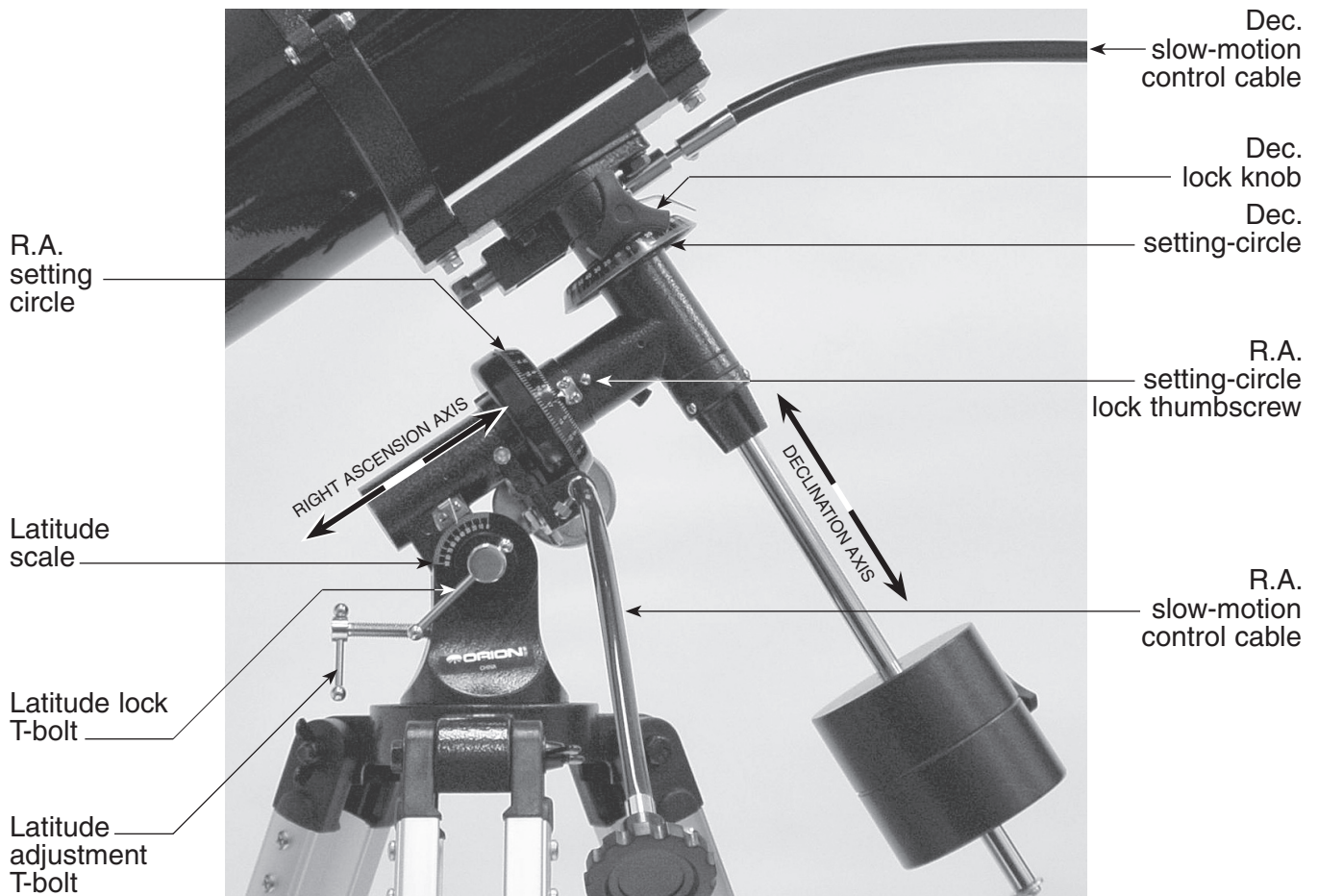

Figure 2. The SpaceProbe 130's equatorial mount.

faces have delicate coatings on them that can be damaged if touched inappropriately. Never remove any lens assembly from its housing for any reason, or the product warranty and return policy will be voided.

1. Lay the equatorial mount on its side. Attach the tripod legs one at a time to the mount using the screws installed in the tops of the tripod legs. Remove the screw from the leg, line up the holes in the top of the leg with the holes in the base of the mount, and reinstall the screw so it passes through the leg and the mount with one washer on both sides of the tripod leg. Tighten the wingnuts only finger-tight, for now.
2. With the tripod legs now attached to the equatorial mount, stand the tripod upright (be careful!) and spread the legs apart until the accessory tray bracket is fully extended.
3. Attach the accessory tray to the accessory tray bracket with the accessory tray wing screws. Push the screws up through the bottom of the bracket and thread them into the accessory tray.
4. Orient the equatorial mount as it appears in Figure 2, at a latitude of about 40°, i.e., so the pointer next to the latitude scale (located directly above the latitude lock T-bolt) is pointing to the mark at "40." To do this, loosen the latitude lock T-bolt, and turn the latitude adjustment T-bolt until the pointer and the "40" line up. Then retighten the latitude lock T-bolt. The declination (Dec.) and right ascension (R.A.) axes may need re-positioning (rotation) as well. Be sure to loosen the RA and Dec. lock knobs before doing this. Retighten the R.A. and Dec. lock knobs once the equatorial mount is properly oriented.
5. Slide the counterweight onto the counterweight shaft. Make sure the counterweight lock knob is adequately loosened to allow the counterweight shaft to pass through the hole in the counterweight.
6. Now, with the counterweight lock knob still loose, grip the counterweight with one hand and thread the shaft into the equatorial mount (at the base of the declination axis) with the other hand. When it is threaded as far in as it will go, position the counterweight about halfway up the shaft and tighten the counterweight lock knob. The retaining screw and washer on the bottom of the shaft prevent the

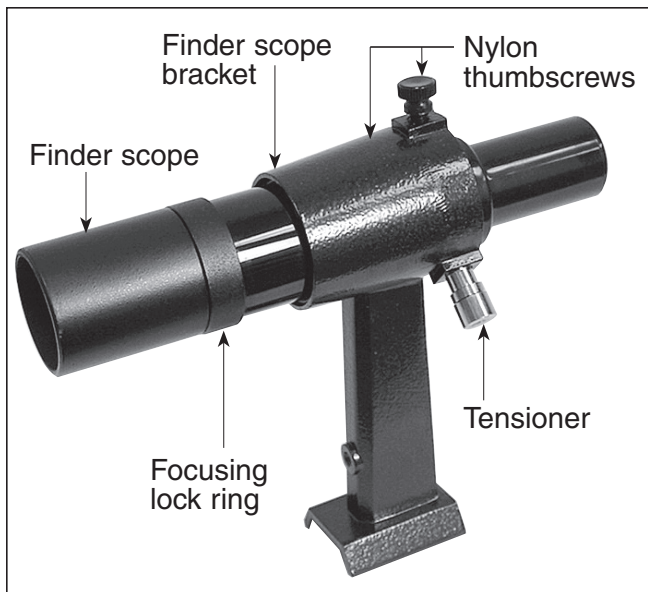

Figure 3a. The 6x26 Correct-Image finder scope

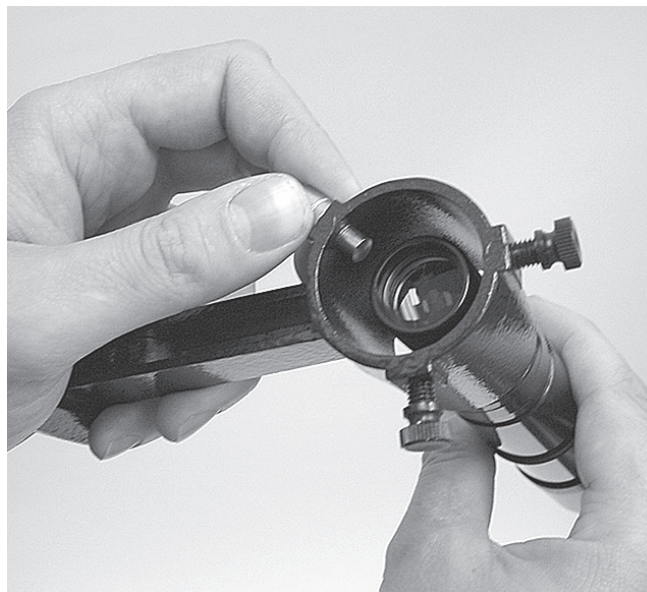

Figure 3b. Pull-back on the tensioner and slide the finder scope into its bracket until the O-ring is seated in the bracket ring

counterweight from falling off (and onto your foot!) if the counterweight lock knob becomes loose.

7. Attach the two tube rings to the equatorial head using the hex head screws that come installed in the bottom of the rings. First remove the screws, then push the screws, with the washers still attached, up through the holes in the tube ring mounting plate (on the top of the equatorial mount) and rethread them into the bottom of the tube rings. Tighten the screws securely with the smaller wrench. Open the tube rings by first loosening the knurled ring clamps. One of the tube rings has a piggyback camera adapter on top (the knurled black ring); ignore it for now, its purpose will be discussed later in detail.
8. Lay the telescope optical tube in the tube rings at about the midpoint of the tube's length. Rotate the tube in the rings so the focuser is angled somewhere between horizontal and straight up. Close the rings over the tube and tighten the knurled ring clamps finger-tight to secure the telescope in position.
9. Now attach the two slow-motion cables to the R.A. and Dec. worm gear shafts of the equatorial mount by positioning the thumb screw on the end of the cable over the indented slot on the worm gear shaft and then tightening the thumb screw. We recommend that the shorter cable be used on the R.A. worm gear shaft and the longer cable on the Dec. worm gear shaft. The Dec. worm gear shaft and cable should extend toward the front (open) end of the telescope optical tube. If it does not, you will need to remove the tube from the mounting rings, rotate the mount 180° about the Dec. axis (first loosen the Dec. lock knob!), and then replace the tube.

10. To place the finder scope in the finder scope bracket, first unthread the two black nylon screws until the screw ends are flush with the inside diameter of the bracket. Place the O-ring that comes on the base of the bracket over the body of the finder scope until it seats into the slot in the middle of the finder scope. Slide the eyepiece end (narrow end) of the finder scope into the end of the bracket's cylinder opposite the alignment screws while pulling the chrome, spring-loaded tensioner on the bracket with your fingers (Figure 3b). Push the finder scope through the bracket until the O-ring seats just inside the front opening of the bracket's cylinder. Now, release the tensioner and tighten the two black nylon screws a couple of turns each to secure the finder scope in place.
11. Insert the base of the finder scope bracket into the dovetail slot near the focuser. Lock the bracket into position by tightening the knurled thumb screw on the dovetail slot.
12. Remove the cap from the focuser and insert the chrome barrel of one of the eyepieces into the drawtube. Secure the eyepiece with the thumb screws on the drawtube. Remember to always loosen the thumb screws before rotating or removing the eyepiece.

The telescope system is now fully assembled. Keep the dust cap over the front end of the telescope when it is not in use.

4. Getting Started

Balancing the Telescope

To insure smooth movement of the telescope on both axes of the equatorial mount, it is imperative that the optical tube be properly balanced. We will first balance the telescope with respect to the R.A. axis, then the Dec. axis.



Figure 4a, 4b, 4c, 4d. Proper operation of the equatorial mount requires that the telescope tube be balanced on both the R.A. and Dec. axes. (a) With the R.A. lock knob released, slide the counterweight along the counterweight shaft until it just counterbalances the tube. (b) When you let go with both hands, the tube should not drift up or down. (c) With the Dec. lock knob released, loosen the tube ring lock clamps a few turns and slide the telescope forward or back in the tube rings. (d) When the tube is balanced about the Dec. axis, it will not move when you let go.

1. Keeping one hand on the telescope optical tube, loosen the R.A. lock lever. Make sure the Dec. lock lever is locked, for now. The telescope should now be able to rotate freely about the R.A. axis. Rotate it until the counterweight shaft is parallel to the ground (i.e., horizontal).
2. Now loosen the counterweight lock knob and slide the weight along the shaft until it exactly counterbalances the telescope (Figure 4a). That's the point at which the shaft remains horizontal even when you let go of the telescope with both hands (Figure 4b).
3. Retighten the counterweight lock knob. The telescope is now balanced on the R.A. axis.
4. To balance the telescope on the Dec. axis, first tighten the R.A. lock knob, with the counterweight shaft still in the horizontal position.
5. With one hand on the telescope optical tube, loosen the Dec. lock knob. The telescope should now be able to rotate freely about the Dec. axis. Loosen the tube ring clamps a few turns, until you can slide the telescope tube forward and back inside the rings (this can be aided by using a slight twisting motion on the optical tube while you push or pull on it) (Figure 4c).

6. Position the telescope so it remains horizontal when you carefully let go with both hands. This is the balance point (Figure 4d). Before clamping the rings tight again, rotate the telescope so the eyepiece is at a convenient angle for viewing. When you are actually observing with the telescope, you can adjust the eyepiece position by loosening the tube rings and rotating the optical tube.
7. Retighten the tube ring clamps.

The telescope is now balanced on both axes. Now when you loosen the lock knob on one or both axes and manually point the telescope, it should move without resistance and should not drift from where you point it.

Focusing the Telescope

Insert the low-power 25mm eyepiece into the focuser and secure with the thumb screws. Move the telescope so the front (open) end is pointing in the general direction of an object at least 1/4-mile away. Now, with your fingers, slowly rotate one of the focusing knobs until the object comes into sharp focus. Go a little bit beyond sharp focus until the image just starts to blur again, then reverse the rotation of the knob, just to make sure you've hit the exact focus point.

If you have trouble focusing, rotate the focus knob so the drawtube is in as far as it will go. Now look through the eye-



Figure 5. The view through a standard finder scope and reflector telescope is upside down (rotated 180°). This is true for the SpaceProbe 130mm and its finder scope as well.

piece while slowly rotating the focus knob in the opposite direction. You should soon see the point at which focus is reached.

Do You Wear Eyeglasses?

If you wear eyeglasses, you may be able to keep them on while you observe, if your eyepieces have enough “eye relief” to allow you to see the whole field of view. You can try this by looking through the eyepiece first with your glasses on and then with them off, and see if the glasses restrict the view to only a portion of the full field. If they do, you can easily observe with your glasses off by just refocusing the telescope the needed amount.

If your eyes are astigmatic, images will probably appear the best with glasses on. This is because a telescope’s focuser can accommodate for nearsightedness or farsightedness, but not astigmatism. If you have to wear your glasses while observing and cannot see the entire field of view, you may want to purchase additional eyepieces that have longer eye relief.

Aligning the Finder Scope

Now, look in the finder scope. Is the object visible? Ideally, it will be somewhere in the finder’s field of view. If it is not, some coarse adjustments of the two black nylon finder scope alignment thumb screws will be needed to get the finder scope roughly parallel to the main tube.

The finder scope must be aligned accurately with the telescope for proper use. To align it, aim the main telescope in the general direction of an object at least 1/4-mile away, such as the top of a telephone pole, a chimney, etc. Do this by first loosening the R.A. and Dec. lock knobs. Position the telescope so the object appears in the eyepiece’s field of view and then retighten the R.A. and Dec. lock knobs. Use the slow-motion control cables to center the object in the eyepiece.

By loosening or tightening the alignment thumb screws, you change the line of sight of the finder scope. Continue making adjustments to the alignment thumb screws until the image in both the finder scope and the telescope’s eyepiece is exactly centered. Check the alignment by moving the telescope to another object and fixing the finder scope’s crosshairs on the exact point you want to look at. Then look through the telescope’s eyepiece to see if that point is centered in the field of view. If it is, the job is done. If not, make the necessary adjustments until the two images match up.

NOTE: *The image in both the finder scope and the main telescope will appear upside-down (rotated 180°). This is normal for finder scopes and reflector telescopes (see Figure 5).*

The finder scope alignment needs to be checked before every observing session. This can easily be done at night, before viewing through the telescope. Choose any bright star or planet, center the object in the telescope eyepiece, and then adjust the finder scope’s alignment screws until the star or planet is also centered on the finder’s crosshairs. The finder scope is an invaluable tool for locating objects in the night sky; its usage for this purpose will be discussed later, in detail.

When transporting the telescope, we recommend removing the finder scope and bracket from the tube. This is done by simply loosening the thumb screw on the dovetail slot. Store the finder scope and bracket in an appropriate eyepiece/accessory case.

Focusing the Finder Scope

If, when looking through the finder scope, the images appear somewhat out of focus, you will need to refocus the finder scope for your eyes. Loosen the lock ring located behind the objective lens cell on the body of the finder scope (see Figure 3a). Back the lock ring off by a few turns, for now. Refocus the finder scope on a distant object by threading the objective lens cell in or out on the finder scope body. Precise focusing will be achieved by focusing the finder scope on a bright star. Once the image appears sharp, retighten the lock ring behind the objective lens cell. The finder scope’s focus should not need to be adjusted again.

5. Setting Up and Using the Equatorial Mount

When you look at the night sky, you no doubt have noticed that the stars appear to move slowly from east to west over time. That apparent motion is caused by the Earth’s rotation (from west to east). An equatorial mount (Figure 2) is designed to compensate for that motion, allowing you to easily “track” the movement of astronomical objects, thereby keeping them from drifting out of the telescope’s field of view while you’re observing.

This is accomplished by slowly rotating the telescope on its right ascension axis, using only the R.A. slow-motion cable. But first the R.A. axis of the mount must be aligned with

the Earth's rotational (polar) axis—a process called polar alignment.

Polar Alignment

For Northern Hemisphere observers, approximate polar alignment is achieved by pointing the mount's R.A. axis at the North Star, or Polaris. It lies within 1° of the north celestial pole (NCP), which is an extension of the Earth's rotational axis out into space. Stars in the Northern Hemisphere appear to revolve around the NCP.

To find Polaris in the sky, look north and locate the pattern of the Big Dipper (Figure 6). The two stars at the end of the "bowl" of the Big Dipper point right to Polaris.

Observers in the Southern Hemisphere aren't so fortunate to have a bright star so near the south celestial pole (SCP). The star Sigma Octantis lies about 1° from the SCP, but it is barely visible with the naked eye (magnitude 5.5).

For general visual observation, an approximate polar alignment is sufficient.

1. Level the equatorial mount by adjusting the length of the three tripod legs.
2. Loosen the latitude lock T-bolt. Turn the latitude adjustment T-bolt and tilt the mount until the pointer on the latitude scale is set at the latitude of your observing site. If you don't know your latitude, consult a geographical atlas to find it. For example, if your latitude is 35° North, set the pointer to 35. Then retighten the latitude lock T-bolt. The latitude setting should not have to be adjusted again unless you move to a different viewing location some distance away.
3. Loosen the Dec. lock knob and rotate the telescope optical tube until it is parallel with the R.A. axis, as it is in Figure 1. The pointer on the Dec. setting circle should read 90° . Retighten the Dec. lock lever.
4. Loosen the azimuth lock knob at the base of the equatorial mount and rotate the mount so the telescope tube (and R.A. axis) points roughly at Polaris. If you cannot see Polaris directly from your observing site, consult a compass and rotate the mount so the telescope points North. Retighten the azimuth lock knob.

The equatorial mount is now polar-aligned for casual observing. More precise polar alignment is required for astrophotography.

From this point on in your observing session, you should not make any further adjustments in the azimuth or the latitude of the mount, nor should you move the tripod. Doing so will undo the polar alignment. The telescope should be moved only about its R.A. and Dec. axes.

Use of the R.A. and Dec. Slow-Motion Control Cables

The R.A. and Dec. slow-motion control cables allow fine adjustment of the telescope's position to center objects within the field of view. Before you can use the cables, you must manually "slew" the mount to point the telescope in the vicinity of the desired target. Do this by loosening the R.A.

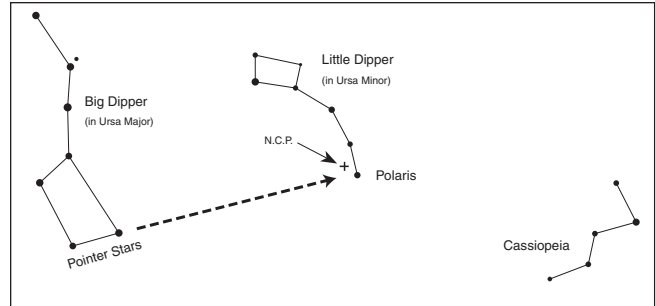

Figure 6. To find Polaris in the night sky, look north and find the Big Dipper. Extend an imaginary line from the two "Pointer Stars" in the bowl of the Big Dipper. Go about five times the distance between those stars and you'll reach Polaris, which lies within 1° of the north celestial pole (NCP).

and Dec. lock knobs and moving the telescope about the mount's R.A. and Dec. axes. Once the telescope is pointed somewhere close to the object to be viewed, retighten the mount's R.A. and Dec. lock knobs.

The object should now be visible somewhere in the telescope's finder scope. If it isn't, use the slow-motion controls to scan the surrounding area of sky. When the object is visible in the finder scope, use the slow-motion controls to center it. Now, look in the telescope with a long focal length (low magnification) eyepiece. If the finder scope is properly aligned, the object should be visible somewhere in the field of view.

Once the object is visible in the telescope's eyepiece, use the slow-motion controls to center it in the field of view. You can now switch to a higher magnification eyepiece, if you wish. After switching eyepieces, you can use the slow-motion control cables to re-center the image, if necessary.

The Dec. slow-motion control cable can move the telescope a maximum of 25° . This is because the Dec. slow-motion mechanism has a limited range of mechanical travel. (The R.A. slow-motion mechanism has no limit to its amount of travel.) If you can no longer rotate the Dec. control cable in a desired direction, you have reached the end of travel, and the slow-motion mechanism should be reset. This is done by first rotating the control cable several turns in the opposite direction from which it was originally being turned. Then, manually slew the telescope closer to the object you wish to observe (remember to first loosen the Dec. lock knob). You should now be able to use the Dec. slow-motion control cable again to fine adjust the telescope's position.

Tracking Celestial Objects

When you observe a celestial object through the telescope, you'll see it drift slowly across the field of view. To keep it in the field, if your equatorial mount is polar aligned, just turn the R.A. slow-motion control cable. The Dec. slow-motion control cable is not needed for tracking. Objects will appear to move faster at higher magnifications, because the field of view is narrower.

Optional Motor Drives for Automatic Tracking

An optional DC motor drive can be mounted on the R.A. axis of the equatorial mount to provide hands-free tracking. Objects will then remain stationary in the field of view without any manual adjustment of the R.A. slow-motion control.

Understanding the Setting Circles

The setting circles on an equatorial mount enable you to locate celestial objects by their “celestial coordinates”. Every object resides in a specific location on the “celestial sphere”. That location is denoted by two numbers: its right ascension (R.A.) and declination (Dec.). In the same way, every location on Earth can be described by its longitude and latitude. R.A. is similar to longitude on Earth, and Dec. is similar to latitude. The R.A. and Dec. values for celestial objects can be found in any star atlas or star catalog.

The R.A. setting circle is scaled in hours, from 1 through 24, with small marks in between representing 10-minute increments (there are 60 minutes in 1 hour of R.A.). The lower set of numbers (closest to the plastic R.A. gear cover) apply to viewing in the Northern Hemisphere, while the numbers above them apply to viewing in the Southern Hemisphere.

The Dec. setting circle is scaled in degrees, with each mark representing 1° increments. Values of Dec. coordinates range from +90° to -90°. For Northern Hemisphere observers, use the numbers on the setting circle that are closest to the eastern horizon. The 0° mark indicates the celestial equator; values north of the Dec. = 0° mark are positive, while values south of the Dec. = 0° mark are negative.

So, the coordinates for the Orion Nebula listed in a star atlas will look like this:

R.A. 5h 35.4m Dec. -5° 27'

That's 5 hours and 35.4 minutes in right ascension, and -5 degrees and 27 arc-minutes in declination (there are 60 arc-minutes in 1 degree of declination).

Before you can use the setting circles to locate objects, the mount must be well polar aligned, and the R.A. setting circle must be calibrated. The Dec. setting circle has been calibrated at the factory, and should read 90° when the telescope optical tube is parallel with the R.A. axis.

Calibrating the Right Ascension Setting Circle

1. Identify a bright star near the celestial equator (Dec. = 0°) and look up its coordinates in a star atlas.
2. Loosen the R.A. and Dec. lock knobs on the equatorial mount, so the telescope optical tube can move freely.
3. Point the telescope at the bright star near the celestial equator whose coordinates you know. Lock the R.A. and Dec. lock knobs. Center the star in the telescope's field of view with the slow-motion control cables.
4. Loosen the R.A. setting circle lock thumb screw located just above the R.A. setting circle pointer; this will allow the setting circle to rotate freely. Rotate the setting circle until the pointer indicates the R.A. coordinate listed in the star atlas for the object. Retighten the thumb screw.

Finding Objects With the Setting Circles

Now that both setting circles are calibrated, look up in a star atlas the coordinates of an object you wish to view.

1. Loosen the Dec. lock knob and rotate the telescope until the Dec. value from the star atlas matches the reading on the Dec. setting circle. Retighten the Dec. lock knob.
2. Loosen the R.A. lock knob and rotate the telescope until the R.A. value from the star atlas matches the reading on the R.A. setting circle. Retighten the lock knob.

Most setting circles are not accurate enough to put an object dead-center in the telescope's eyepiece, but they should place the object somewhere within the field of view of the finder scope, assuming the equatorial mount is accurately polar-aligned. Use the slow-motion controls to center the object in the finder scope, and it should appear in the telescope's field of view.

Confused About Pointing the Telescope?

Beginners occasionally experience some confusion about how to point the telescope overhead or in other directions. In Figure 1 the telescope is pointed north, as it would be during polar alignment. The counterweight shaft is oriented downward. But it will not look like that when the telescope is pointed in other directions. Let's say you want to view an object that is directly overhead, at the zenith. How do you do it?

One thing you DO NOT do is make any adjustment to the latitude adjustment T-bolt. That will nullify the mount's polar alignment. Remember, once the mount is polar-aligned, the telescope should be moved only on the R.A. and Dec. axes. To point the scope overhead, first loosen the R.A. lock knob and rotate the telescope on the R.A. axis until the counterweight shaft is horizontal (parallel to the ground). Then loosen the Dec. lock knob and rotate the telescope until it is pointing straight overhead. The counterweight shaft is still horizontal. Then retighten both lock levers.

Similarly, to point the telescope directly south, the counterweight shaft should again be horizontal. Then you simply rotate the scope on the Dec. axis until it points in the south direction.

What if you need to aim the telescope directly north, but at an object that is nearer to the horizon than Polaris? You can't do it with the counterweight down as pictured in Figure 1. Again, you have to rotate the scope in R.A. so the counterweight shaft is positioned horizontally. Then rotate the scope in Dec. so it points to where you want it near the horizon.

To point the telescope to the east or west, or in other directions, you rotate the telescope on its R.A. and Dec. axes. Depending on the altitude of the object you want to observe, the counterweight shaft will be oriented somewhere between vertical and horizontal.

Figure 7 illustrates how the telescope will look pointed at the four cardinal directions—north, south, east, and west

To point the telescope to the east or west, or in other directions, you rotate the telescope on its R.A. and Dec. axes. Depending on the altitude of the object you want to observe,

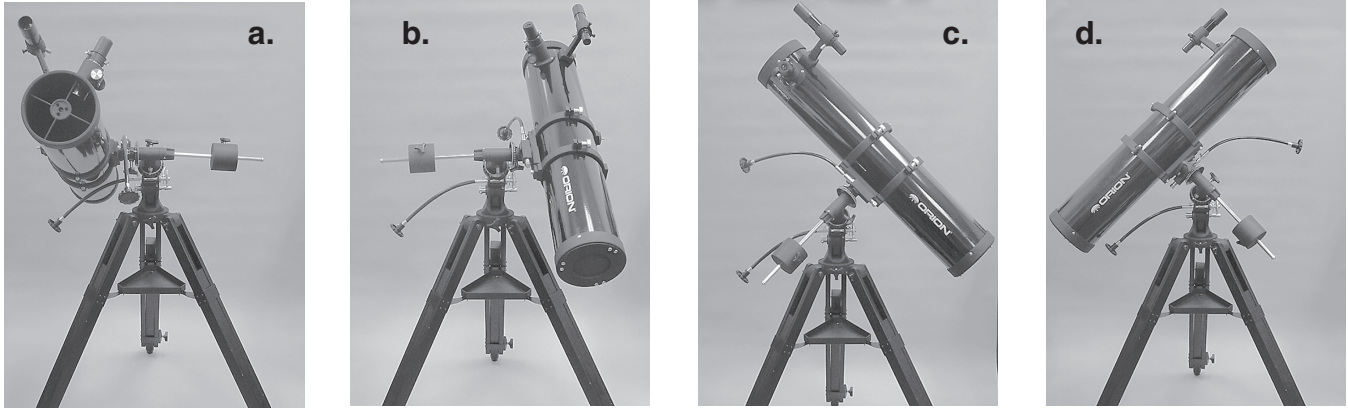

Figure 7. This illustration shows the telescope pointed in the four cardinal directions: (a) north, (b) south, (c) east, (d) west. Note that the tripod and mount have not been moved; only the telescope tube has been moved on the R.A. and Dec. axes.

the counterweight shaft will be oriented somewhere between vertical and horizontal.

The key things to remember when pointing the telescope is that a) you only move it in R.A. and Dec., not in azimuth or latitude (altitude), and b) the counterweight and shaft will not always appear as it does in Figure 1. In fact, it almost never will!

6. Collimating the Optics (Aligning the Mirrors)

Collimation is the process of adjusting the mirrors so they are perfectly aligned with one another. Your telescope's optics were aligned at the factory, and should not need much adjustment unless the telescope is handled roughly. Accurate mirror alignment is important to ensure the peak performance of your telescope, so it should be checked regularly. Collimation is relatively easy to do and can be done in daylight.

To check collimation, remove the eyepiece and look down the focuser drawtube. You should see the secondary mirror centered in the drawtube, as well as the reflection of the primary mirror centered in the secondary mirror, and the reflection of the secondary mirror (and your eye) centered in the reflection of the primary mirror, as in figure 8a. If anything is off-center, as in figure 8b, proceed with the following collimation procedure.

The Collimation Cap and Mirror Center Mark

Your SpaceProbe 130 EQ comes with a collimation cap. This is a simple cap that fits on the focuser drawtube like a dust cap, but has a hole in the center and a silver bottom. This helps center your eye so that collimation is easy to perform. Figures 8b through 8e assume you have the collimation cap in place.

In addition to providing the collimation cap, you'll notice a tiny ring (sticker) in the exact center of the primary mirror. This "center mark" allows you to achieve a very precise collimation of the primary mirror; you don't have to guess where the

center of the mirror is. You simply adjust the mirror position (described below) until the reflection of the hole in the collimation cap is centered inside the ring. This center mark is also required for best results with other collimating devices, such as Orion's LaserMate Laser Collimator, obviating the need to remove the primary mirror and mark it yourself.

NOTE: *The center ring sticker need not ever be removed from the primary mirror. Because it lies directly in the shadow of the secondary mirror, its presence in no way adversely affects the optical performance of the telescope or the image quality. That might seem counter-intuitive, but it's true!*

Aligning the Secondary Mirror

With the collimation cap in place, look through the hole in the cap at the secondary (diagonal) mirror. Ignore the reflections for the time being. The secondary mirror itself should be centered in the focuser drawtube, in the direction parallel to the length of the telescope. If it isn't, as in figure 8b, it must be adjusted. Typically, this adjustment will rarely, if ever, need to be done. It helps to adjust the secondary mirror in a brightly lit room with the telescope pointed toward a bright surface, such as white paper or wall. Placing a piece of white paper in the telescope tube opposite the focuser (i.e., on the other side of the secondary mirror) will also be helpful in collimating the secondary mirror. Using a 2mm Allen wrench, loosen the three small alignment set screws in the center hub of the 4-vaned spider several turns. Now hold the mirror holder stationary (be careful not to touch the surface of the mirrors), while turning the center screw with a Phillips head screwdriver (see Figure 9). Turning the screw clockwise will move the secondary mirror toward the front opening of the optical tube, while turning the screw counter-clockwise will move the secondary mirror toward the primary mirror.

When the secondary mirror is centered in the focuser drawtube, rotate the secondary mirror holder until the reflection of the primary mirror is as centered in the secondary mirror as possible. It may not be perfectly centered, but that is OK. Now tighten the three small alignment screws equally to secure the secondary mirror in that position.

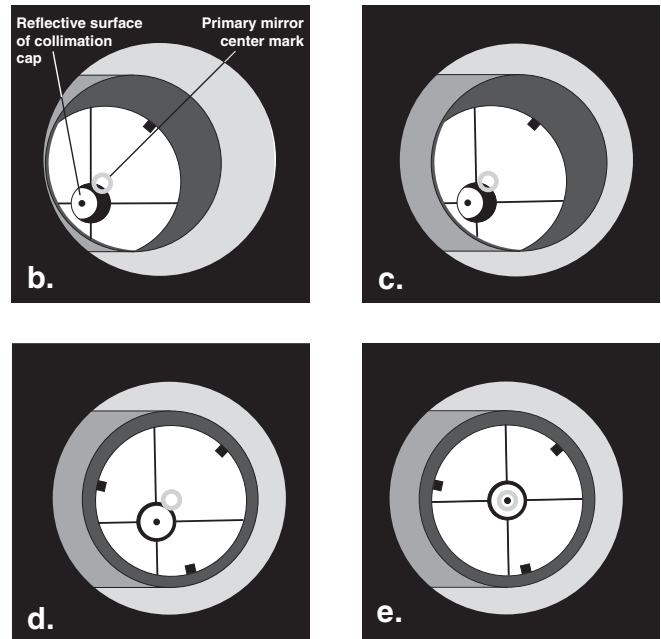
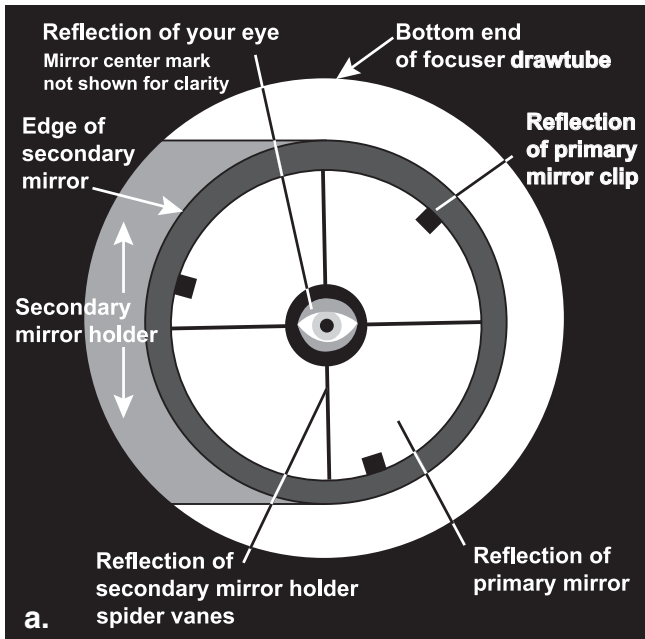

Figure 8. Collimating the optics. (a) When the mirrors are properly aligned, the view down the focuser drawtube should look like this. (b) With the collimation cap in place, if the optics are out of alignment, the view might look something like this. (c) Here, the secondary mirror is centered under the focuser, but it needs to be adjusted (tilted) so that the entire primary mirror is visible. (d) The secondary mirror is correctly aligned, but the primary mirror still needs adjustment. When the primary mirror is correctly aligned, the “dot” will be centered, as in (e).

If the entire primary mirror reflection is not visible in the secondary mirror, as in Figure 8c, you will need to adjust the tilt of the secondary mirror. This is done by alternately loosening one of the three alignment setscrews while tightening the other two, as depicted in Figure 10. The goal is to center the primary mirror reflection in the secondary mirror, as in Figure 8d. Don't worry that the reflection of the secondary mirror (the smallest circle, with the collimation cap “dot” in the center) is off-center. You will fix that in the next step.

Adjusting the Primary Mirror

The final adjustment is made to the primary mirror. It will need adjustment if, as in Figure 8d, the secondary mirror is centered under the focuser and the reflection of the primary mirror is centered in the secondary mirror, but the small reflection of the secondary mirror (with your eye inside) is off-center.

The tilt of the primary is adjusted with the three pairs of collimation screws on the back end of the optical tube (bottom of the mirror cell, see Figure 11). The collimation screws can be turned with a Phillips head screwdriver.

Each pair of collimation screws work together to adjust the tilt. One screw pushes the mirror cell forward, while the other screw pulls the mirror cell back. One must be loosened and the other tightened by the same amount in order to adjust the tilt. Try tightening and loosening one of the pairs of Phillips-headed collimation screws one turn. Look into the focuser and see if the secondary mirror reflection has moved closer to the center of the primary mirror reflection. Repeat this process on the other two pairs of collimation screws, if necessary. It will take a little trial and error to get a feel for how to

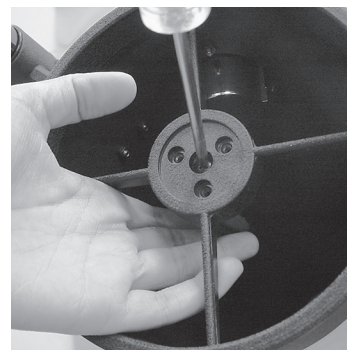

Figure 9. To center the secondary mirror under the focuser, hold the secondary mirror holder in place with one hand while adjusting the center bolt with a Phillips screwdriver. Do not touch the mirror's surface!

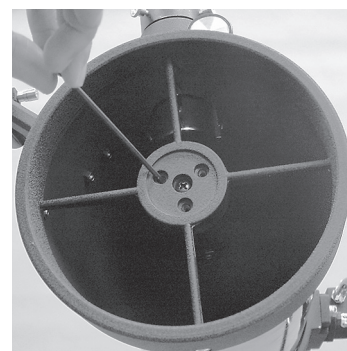

Figure 10. Adjust the tilt of the secondary mirror by loosening or tightening the three alignment setscrews with a 2mm allen wrench

tilt the mirror in this way to center the reflection. Look into the focuser and see if the secondary reflection has moved closer to the center of the primary. You can tell this easily with the collimation cap and mirror center mark by simply watching



Figure 11. The back end of the optical tube (bottom of the primary mirror cell). The three pairs of collimation screws adjust the tilt of the primary mirror.

to see if the “dot” of the collimation cap is moving closer or further away from being centered in the “ring” of the primary mirror. When you have the dot centered as much as possible in the ring, your primary mirror is collimated. The view through the collimation cap should resemble Figure 8e.

A simple star test will tell you whether the optics are accurately collimated.

Star-Testing the Telescope

When it is dark, point the telescope at a bright star and accurately center it in the eyepiece’s field of view. Slowly de-focus the image with the focusing knob. If the telescope is correctly collimated, the expanding disk should be a perfect circle (Figure 12). If the image is unsymmetrical, the scope is out of collimation. The dark shadow cast by the secondary mirror should appear in the very center of the out-of-focus circle, like the hole in a donut. If the “hole” appears off-center, the telescope is out of collimation.

If you try the star test and the bright star you have selected is not accurately centered in the eyepiece, the optics will always appear out of collimation, even though they may be perfectly aligned. It is critical to keep the star centered, so over time you will need to make slight corrections to the telescope’s position in order to account for the sky’s apparent motion.

7. Using Your Telescope—Astronomical Observing

Choosing an Observing Site

When selecting a location for observing, get as far away as possible from direct artificial light such as street lights, porch lights, and automobile headlights. The glare from these lights will greatly impair your dark-adapted night vision. Set up on a grass or dirt surface, not asphalt, because asphalt radiates more heat. Heat disturbs the surrounding air and degrades the images seen through the telescope. Avoid viewing over rooftops and chimneys, as they often have warm air currents rising from them. Similarly, avoid observing from indoors through an open (or closed) window, because the temperature difference between the indoor and outdoor air will cause image blurring and distortion.

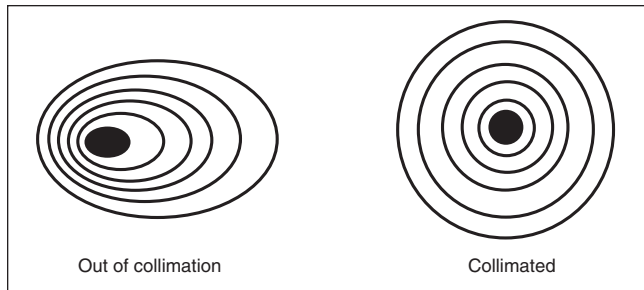

Figure 12. A star test will determine if a telescope’s optics are properly collimated. An unfocused view of a bright star through the eyepiece should appear as illustrated on the right if the optics are perfectly collimated. If the circle is unsymmetrical, as in the illustration on the left, the scope needs collimation.

If at all possible, escape the light-polluted city sky and head for darker country skies. You’ll be amazed at how many more stars and deep-sky objects are visible in a dark sky!

“Seeing” and Transparency

Atmospheric conditions play a huge part in quality of viewing. In conditions of good “seeing”, star twinkling is minimal and objects appear steady in the eyepiece. Seeing is best overhead, worst at the horizon. Also, seeing generally gets better after midnight, when much of the heat absorbed by the Earth during the day has radiated off into space. Typically, seeing conditions will be better at sites that have an altitude over about 3000 feet. Altitude helps because it decreases the amount of distortion causing atmosphere you are looking through.

A good way to judge if the seeing is good or not is to look at bright stars about 40° above the horizon. If the stars appear to “twinkle”, the atmosphere is significantly distorting the incoming light, and views at high magnifications will not appear sharp. If the stars appear steady and do not twinkle, seeing conditions are probably good and higher magnifications will be possible. Also, seeing conditions are typically poor during the day. This is because the heat from the Sun warms the air and causes turbulence.

Good “transparency” is especially important for observing faint objects. It simply means the air is free of moisture, smoke, and dust. All tend to scatter light, which reduces an object’s brightness.

One good way to tell if conditions are good is by how many stars you can see with your naked eye. If you cannot see stars of magnitude 3.5 or dimmer then conditions are poor. Magnitude is a measure of how bright a star is, the brighter a star is, the lower its magnitude will be. A good star to remember for this is Megrez (mag. 3.4), which is the star in the ‘Big Dipper’ connecting the handle to the ‘dipper’. If you cannot see Megrez, then you have fog, haze, clouds, smog, or other conditions that are hindering your viewing (Figure 13).

Cooling the Telescope

All optical instruments need time to reach “thermal equilibrium”. The bigger the instrument and the larger the tempera-

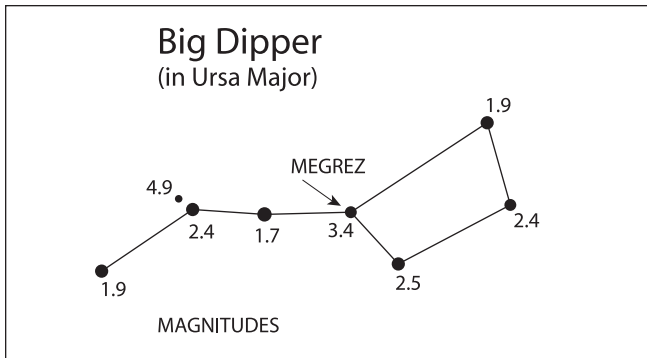

Figure 13. Megrez connects the Big Dipper's handle to its "pan". It is a good guide to how conditions are. If you can not see Megrez (a 3.4 mag star) then conditions are poor.

ture change, the more time is needed. Allow at least 30 minutes for your telescope to cool to the temperature outdoors. In very cold climates (below freezing), it is essential to store the telescope as cold as possible. If it has to adjust to more than a 40° temperature change, allow at least one hour.

Let Your Eyes Dark-Adapt

Don't expect to go from a lighted house into the darkness of the outdoors at night and immediately see faint nebulas, galaxies, and star clusters—or even very many stars, for that matter. Your eyes take about 30 minutes to reach perhaps 80% of their full dark-adapted sensitivity. As your eyes become dark-adapted, more stars will glimmer into view and you'll be able to see fainter details in objects you view in your telescope.

To see what you're doing in the darkness, use a red-filtered flashlight rather than a white light. Red light does not spoil your eyes' dark adaptation like white light does. A flashlight with a red LED light is ideal, or you can cover the front of a regular incandescent flashlight with red cellophane or paper. Beware, too, that nearby porch and streetlights and car headlights will ruin your night vision.

Calculating the Magnification

Magnification, or power, is determined by the focal length of the telescope and the focal length of the eyepiece. Therefore, by using eyepieces of different focal lengths, the resultant magnification can be varied.

Magnification is calculated as follows:

$$\text{Magnification} = \frac{\text{Telescope Focal Length (mm)}}{\text{Eyepiece Focal Length (mm)}}$$

For example, the SpaceProbe 130mm EQ, which has a focal length of 900mm, used in combination with the included 25mm Explorer II eyepiece, yields a magnification of

$$900\text{mm} \div 25\text{mm} = 36\text{x}$$

Every telescope has a useful magnification limit of about 45x-60x per inch of aperture. Your SpaceProbe 130 has an aperture of about 5.1", so the maximum magnification would be approximately 230x-300x. Claims of higher power by some telescope manufacturers are a misleading adver-

tising gimmick and should be dismissed. Keep in mind that at higher powers, an image will always be dimmer and less sharp (this is a fundamental law of optics). The steadiness of the air (the "seeing") can also limit how much magnification an image can tolerate.

Eyepiece Selection

By using eyepieces of varying focal lengths, it is possible to attain a great many magnifications with the SpaceProbe 130mm EQ. The telescope comes with two high-quality Sirius Plössl eyepieces: a 25mm, which gives a magnification of 36x and a 10mm, which gives a magnification of 90x. Other eyepieces can be used to achieve higher or lower powers. It is quite common for an observer to own five or more eyepieces to access a wide range of magnifications. This allows the observer to choose the best eyepiece to use depending on the object being viewed. At least to begin with, the two supplied eyepieces will suffice nicely.

Whatever you choose to view, always start by inserting your lowest-power (longest focal length) eyepiece to locate and center the object. Low magnification yields a wide field of view, which shows a larger area of sky in the eyepiece. This makes acquiring and centering an object much easier. If you try to find and center objects with high power (narrow field of view), it's like trying to find a needle in a haystack!

Once you've centered the object in the eyepiece, you can switch to higher magnification (shorter focal length eyepiece), if you wish. This is especially recommended for small and bright objects, like planets and double stars. The Moon also takes higher magnifications well.

Deep-sky objects, however, typically look better at medium or low magnifications. This is because many of them are quite faint, yet have some extent (apparent width). Deep-sky objects will often disappear at higher magnifications, since greater magnification inherently yields dimmer images. This is not the case for all deep-sky objects, however. Many galaxies are quite small, yet are somewhat bright, so higher power may show more detail.

The best rule of thumb with eyepiece selection is to start with a low power, wide field, and then work your way up in magnification. If the object looks better, try an even higher magnification. If the object looks worse, then back off the magnification a little by using a lower-power eyepiece.

Objects to Observe

Now that you are all set up and ready to go, one critical decision must be made: what to look at?

A. The Moon

With its rocky surface, the Moon is one of the easiest and most interesting targets to view with your telescope. Lunar craters, marias, and even mountain ranges can all be clearly seen from a distance of 238,000 miles away! With its ever-changing phases, you'll get a new view of the Moon every night. The best time to observe our one and only natural satellite is during a partial phase, that is, when the Moon is NOT full. During partial phases, shadows are cast on the surface, which reveal more detail, especially right along the border

between the dark and light portions of the disk (called the “terminator”). A full Moon is too bright and devoid of surface shadows to yield a pleasing view. Make sure to observe the Moon when it is well above the horizon to get the sharpest images.

Use an optional Moon filter to dim the Moon when it is very bright. It simply threads onto the bottom of the eyepieces (you must first remove the eyepiece from the focuser to attach a filter). You’ll find that the Moon filter improves viewing comfort, and also helps to bring out subtle features on the lunar surface.

B. The Sun

You can change your nighttime telescope into a daytime Sun viewer by installing an optional full-aperture solar filter over the front opening of the SpaceProbe 130mm EQ. The primary attraction is sunspots, which change shape, appearance, and location daily. Sunspots are directly related to magnetic activity in the Sun. Many observers like to make drawings of sunspots to monitor how the Sun is changing from day to day.

Important Note: *Do not look at the Sun with any optical instrument without a professionally made solar filter, or permanent eye damage could result. Leave the cover caps on the finder scope, or better yet, remove the finder scope from the telescope tube when solar viewing.*

C. The Planets

The planets don’t stay put like the stars, so to find them you should refer to Sky Calendar at our website (telescope.com), or to charts published monthly in *Astronomy*, *Sky & Telescope*, or other astronomy magazines. Venus, Mars, Jupiter, and Saturn are the brightest objects in the sky after the Sun and the Moon. Your SpaceProbe 130mm EQ is capable of showing you these planets in some detail. Other planets may be visible but will likely appear star-like. Because planets are quite small in apparent size, optional higher-power eyepieces are recommended and often needed for detailed observations. Not all the planets are generally visible at any one time.

JUPITER The largest planet, Jupiter, is a great subject for observation. You can see the disk of the giant planet and watch the ever-changing positions of its four largest moons—Io, Callisto, Europa, and Ganymede. Higher-power eyepieces should bring out the cloud bands on the planet’s disk.

SATURN The ringed planet is a breathtaking sight when it is well positioned. The tilt angle of the rings varies over a period of many years; sometimes they are seen edge-on, while at other times they are broadside and look like giant “ears” on each side of Saturn’s disk. A steady atmosphere (good seeing) is necessary for a good view. You will probably see a bright “star” close by, which is Saturn’s brightest moon, Titan.

VENUS At its brightest, Venus is the most luminous object in the sky, excluding the Sun and the Moon. It is so bright that sometimes it is visible to the naked eye during full daylight! Ironically, Venus appears as a thin crescent, not a full disk, when at its peak brightness. Because it is so close to the

Sun, it never wanders too far from the morning or evening horizon. No surface markings can be seen on Venus, which is always shrouded in dense clouds.

MARS The Red Planet makes its closest approach to Earth every two years. During close approaches you’ll see a red disk, and may be able to see the polar ice cap. To see surface detail on Mars, you will need a high-power eyepiece and very steady air!

E. The Stars

Stars will appear like twinkling points of light. Even powerful telescopes cannot magnify stars to appear as more than a point of light! You can, however, enjoy the different colors of the stars and locate many pretty double and multiple stars. The famous “Double-Double” in the constellation Lyra and the gorgeous two-color double star Albireo in Cygnus are favorites. Defocusing a star slightly can help bring out its color.

F. Deep-Sky Objects

Under dark skies, you can observe a wealth of fascinating deep-sky objects, including gaseous nebulas, open and globular star clusters, and a variety of different types of galaxies. Most deep-sky objects are very faint, so it is important that you find an observing site well away from light pollution. Take plenty of time to let your eyes adjust to the darkness. Do not expect these subjects to appear like the photographs you see in books and magazines; most will look like dim gray smudges. Our eyes are not sensitive enough to see color in deep-sky objects except in a few of the brightest ones. But as you become more experienced and your observing skills get sharper, you will be able to ferret out more and more subtle details and structure.

How to Find Deep-Sky Objects: Star Hopping

Star hopping, as it is called by astronomers, is perhaps the simplest way to hunt down deep-sky objects to view in the night sky. It entails first pointing the telescope at a star close to the object you wish to observe, and then progressing to other stars closer and closer to the object until it is in the field of view of the eyepiece. It is a very intuitive technique that has been employed for hundreds of years by professional and amateur astronomers alike. Keep in mind, as with any new task, that star hopping may seem challenging at first, but will become easier over time and with practice.

To starhop, only a minimal amount of additional equipment is necessary. A star chart or atlas that shows stars to at least magnitude 5 is required. Select one that shows the positions of many deep-sky objects, so you will have a lot of options to choose from. If you do not know the positions of the constellations in the night sky, you will need to get a planisphere to identify them.

Start by choosing bright objects to view. The brightness of an object is measured by its visual magnitude; the brighter an object, the lower its magnitude. Choose an object with a visual magnitude of 9 or lower. Many beginners start with the Messier objects, which represent some of the best and

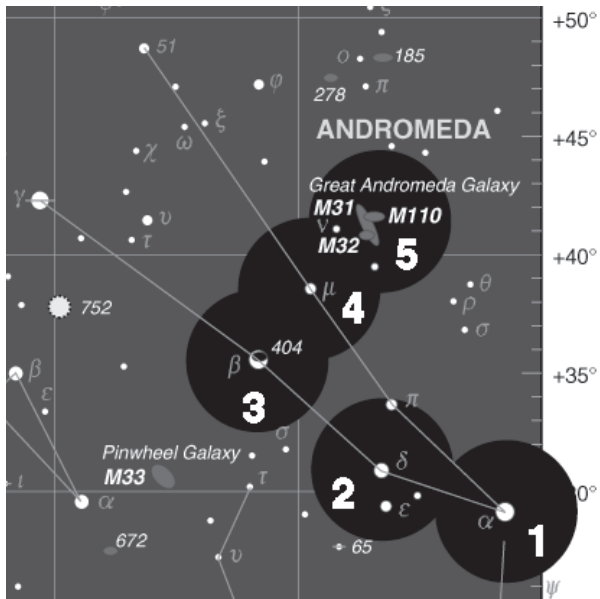

Figure 14. Star hopping is a good way to locate hard-to-find objects. Refer to a star chart to map a route to the object that uses bright stars as guideposts. Center the first star you've chosen in the finder scope and telescope eyepiece (1). Now move the scope carefully in the direction of the next bright star (2), until it is centered. Repeat (3 and 4). The last hop (5) should place the desired object in the eyepiece.

brightest deep-sky objects, first catalogued about 200 years ago by the French astronomer Charles Messier.

Determine in which constellation the object lies. Now, find the constellation in the sky. If you do not recognize the constellations on sight, consult a planisphere. The planisphere gives an all-sky view and shows which constellations are visible on a given night at a given time.

Now, look at your star chart and find the brightest star in the constellation that is near the object you are trying to find. Using the finder scope, point the telescope at this star and center it on the crosshairs. Next, look again at the star chart and find another suitably bright star near the bright star currently centered in the finder. Keep in mind that the field of view of the finder scope is 7° , so you should choose another star that is no more than 7° from the first star, if possible. Move the telescope slightly, until the telescope is centered on the new star.

Continue using stars as guideposts in this way until you are at the approximate position of the object you are trying to find (Figure 14). Look in the telescope's eyepiece, and the object should be somewhere within the field of view. If it's not, sweep the telescope carefully around the immediate vicinity until the object is found.

If you have trouble finding the object, start the starhop again from the brightest star near the object you wish to view. This time, be sure the stars indicated on the star chart are in fact the stars you are centering in the eyepiece. Remember, the finder scope (and main telescope eyepiece, for that matter)

gives an inverted image, so you must keep this in mind when star hopping from star to star.

8. Care and Maintenance

If you give your telescope reasonable care, it will last a lifetime. Store it in a clean, dry, dust-free place, safe from rapid changes in temperature and humidity. Do not store the telescope outdoors, although storage in a garage or shed is OK. Small components like eyepieces and other accessories should be kept in a protective box or storage case. Keep the caps on the front of the telescope and on the focuser draw-tube when it is not in use.

Your SpaceProbe 130mm EQ telescope requires very little mechanical maintenance. The optical tube is steel and has a smooth painted finish that is fairly scratch-resistant. If a scratch does appear on the tube, it will not harm the telescope. If you wish, you may apply some auto touch-up paint to the scratch. Smudges on the tube can be wiped off with a soft cloth and a household cleaner such as Windex or Formula 409.

Cleaning Lenses

Any quality optical lens cleaning tissue and optical lens cleaning fluid specifically designed for multi-coated optics can be used to clean the exposed lenses of your eyepieces or finder scope. Never use regular glass cleaner or cleaning fluid designed for eyeglasses. Before cleaning with fluid and tissue, however, blow any loose particles off the lens with a blower bulb or compressed air. Then apply some cleaning fluid to a tissue, never directly on the optics. Wipe the lens gently in a circular motion, then remove any excess fluid with a fresh lens tissue. Oily fingerprints and smudges may be removed using this method. Use caution; rubbing too hard may scratch the lens. On larger lenses, clean only a small area at a time, using a fresh lens tissue on each area. Never reuse tissues.

Cleaning Mirrors

You should not have to clean your telescope's mirrors very often; normally once every year or so. Covering your telescope when it is not in use will prevent dust from accumulating on the mirrors. Improper cleaning can scratch mirror coatings, so the fewer times you have to clean the mirrors, the better. Small specks of dust or flecks of paint have virtually no effect on the visual performance of the telescope.

The large primary mirror and the elliptical secondary mirror of your telescope are front-surface aluminized and overcoated with hard silicon dioxide, which prevents the aluminum from oxidizing. These coatings normally last through many, many years of use before requiring re-coating (which is easily done).

To clean the secondary mirror, remove the mirror in its holder from the 4-vaned spider in the tube. Do this by grasping the secondary mirror holder with your fingertips while turning the central screw on the spider's central hub counterclockwise. Handle the mirror holder only; do not touch the mirror surface. Also be sure not to lose the spring behind the mirror holder.

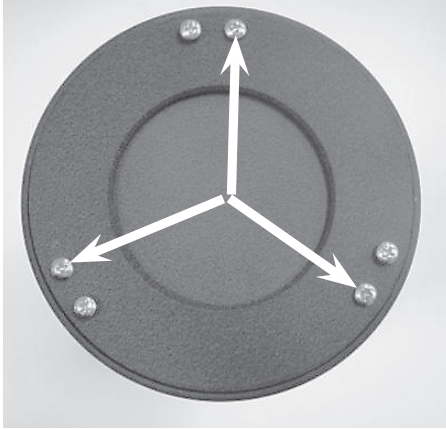

Figure 15.
Remove the three collimation screws indicated to remove the mirror cell from the tube.

Then follow the same procedure described below for cleaning the primary mirror. The secondary mirror is glued into its holder, and should not be removed from the holder for cleaning.

To clean the primary mirror, carefully remove the mirror cell from the telescope. This is done by first removing the three primary mirror collimation screws indicated in Figure 15. Next, remove the primary mirror from the mirror cell; you will need to remove the three mirror clips to do this. Completely unthread the two Phillips head screws in each clip, and carefully lift the mirror from its cell. Be careful not to touch the front surface of the mirror with your fingers! Set the mirror on a clean, soft towel. Fill a clean sink, free of abrasive cleanser, with room-temperature water, a few drops of liquid dishwashing detergent, and if possible, a cap-full of rubbing alcohol. Submerge the mirror (aluminized face up) in the water and let it soak for several minutes (or hours if it's a very dirty mirror). Wipe the mirror under water with clean cotton balls, using extremely light pressure and stroking in straight lines across the surface. Use one ball for each wipe across the mirror.

Then rinse the mirror under a stream of lukewarm water. Any particles on the surface can be swabbed gently with a series of clean cotton balls, each used just one time. Dry the mirror in a stream of air (a "blower bulb" works great), or remove any stray drops of water with the corner of a paper towel. Water will run off a clean surface. Cover the mirror surface with Kleenex, and leave the entire assembly in a warm area until it is completely dry before reassembling the telescope.

9. Specifications

Optical tube: Steel

Primary mirror diameter: 130mm

Primary mirror coating: Aluminized, silicon dioxide overcoat

Secondary mirror minor axis: 34mm

Focal length: 900mm

Focal ratio: f/7

Eyepieces: 25mm and 10mm Explorer II, fully coated, 1.25"

Magnification: 36x (with 25mm), 90x (with 10mm)

Focuser: Rack and pinion

Finder scope: 6x magnification, 30mm aperture, achromatic, crosshairs

Mount: EQ-2 German-type equatorial

Tripod: Aluminum

Motor drives: Optional

One-Year Limited Warranty

This Orion SpaceProbe 130mm Equatorial Reflector is warranted against defects in materials or workmanship for a period of one year from the date of purchase. This warranty is for the benefit of the original retail purchaser only. During this warranty period Orion Telescopes & Binoculars will repair or replace, at Orion's option, any warranted instrument that proves to be defective, provided it is returned postage paid to: Orion Warranty Repair, 89 Hangar Way, Watsonville, CA 95076. If the product is not registered, proof of purchase (such as a copy of the original invoice) is required.

This warranty does not apply if, in Orion's judgment, the instrument has been abused, mishandled, or modified, nor does it apply to normal wear and tear. This warranty gives you specific legal rights, and you may also have other rights, which vary from state to state. For further warranty service information, contact: Customer Service Department, Orion Telescopes & Binoculars, 89 Hangar Way, Watsonville, CA 95076; (800) 676-1343.

Orion Telescopes & Binoculars

89 Hangar Way, Watsonville, CA 95076

Customer Support Help Line (800) 676-1343 • Day or Evening